

WAAS CH 90239 W18A	APP CRS 181°	Rwy ldg 4894 TDZE 738 Apt Elev 738
--	------------------------	---

RNAV (GPS) RWY 18

RANTOUL NTL AVN CNTR-FRANK ELLIOTT FLD (TIP)

For uncompensated Baro-VNAV systems, LNAV/VNAV NA below -16°C (4°F) or above 54°C (130°F). Baro-VNAV and VDP NA when using Champaign Urbana altimeter setting. DME/DME RNP-0.3 NA. Helicopter visibility reduction below ¼ SM NA. When local altimeter setting not received, use Champaign Urbana altimeter setting and increase LPV DA to 1056 and all visibilities to 1½ mile, increase LNAV/VNAV DA to 1312 and all visibilities to 2 mile; increase all MDA 60 feet; increase LNAV and Circling Cats C/D visibility ¼ mile.

MISSED APPROACH: Climb to 3000 direct BELMY and hold.

AWOS-3 119.025	CHAMPAIGN APP CON ★ 121.35 285.65	UNICOM 123.0 (CTAF) 1
--------------------------	---	---------------------------------

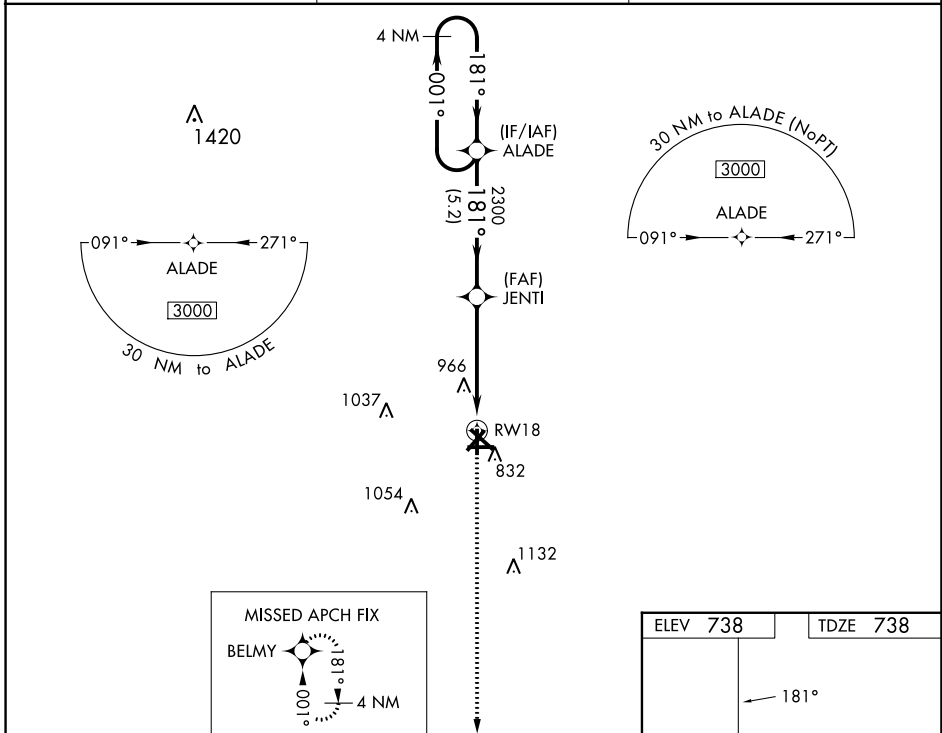

EC-3, 22 FEB 2024 to 21 MAR 2024

EC-3, 22 FEB 2024 to 21 MAR 2024

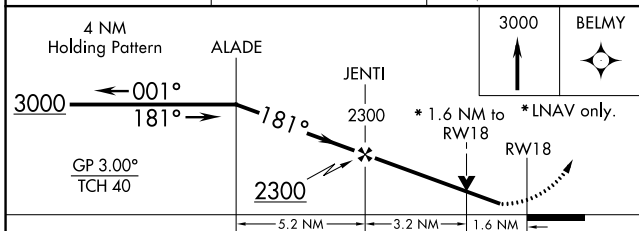
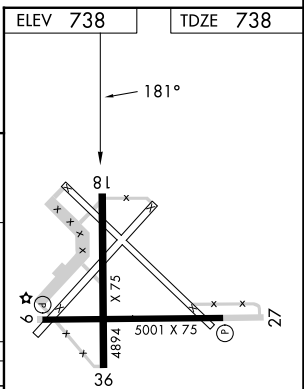
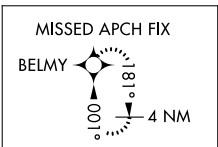

CATEGORY	A	B	C	D
LPV DA	1015-1		277 (300-1)	
LNAV/VNAV DA	1271-17/8		533 (600-17/8)	
LNAV MDA	1280-1	542 (600-1)	1280-17/8	542 (600-17/8)
CIRCLING	1280-1	542 (600-1)	1380-13/4	1420-21/4
			642 (700-13/4)	682 (700-21/4)

REIL Rwy 9 and 27 1
MIRL Rwy 9-27 and 18-36 1

WAAS CH 42737 W27A	APP CRS 271°	Rwy Idg TDZE 733 Apt Elev 738	5001
--	------------------------	---	-------------

RNAV (GPS) RWY 27

RANTOUL NTL AVN CNTR-FRANK ELLIOTT FLD (TIP)

⚠ For uncompensated Baro-VNAV systems, LNAV/VNAV NA below -16°C (4°F) or above 54°C (130°F). DME/DME RNP-0.3 NA. When local altimeter setting not received, use Champaign Urbana altimeter setting and increase all DA 41 feet and all MDA 60 feet; increase LNAV/VNAV all Cats visibility 1/8 mile and LNAV and Circling Cats C/D visibility 1/4 mile. Baro-VNAV and VDP NA when using Champaign Urbana altimeter setting. Helicopter visibility reduction below 1/4 SM NA.

MISSED APPROACH:
Climb to 3000 direct LEVVI and hold.

AWOS-3 119.025	CHAMPAIGN APP CON ★ 121.35 285.65	UNICOM 123.0 (CTAF) ①
--------------------------	---	--

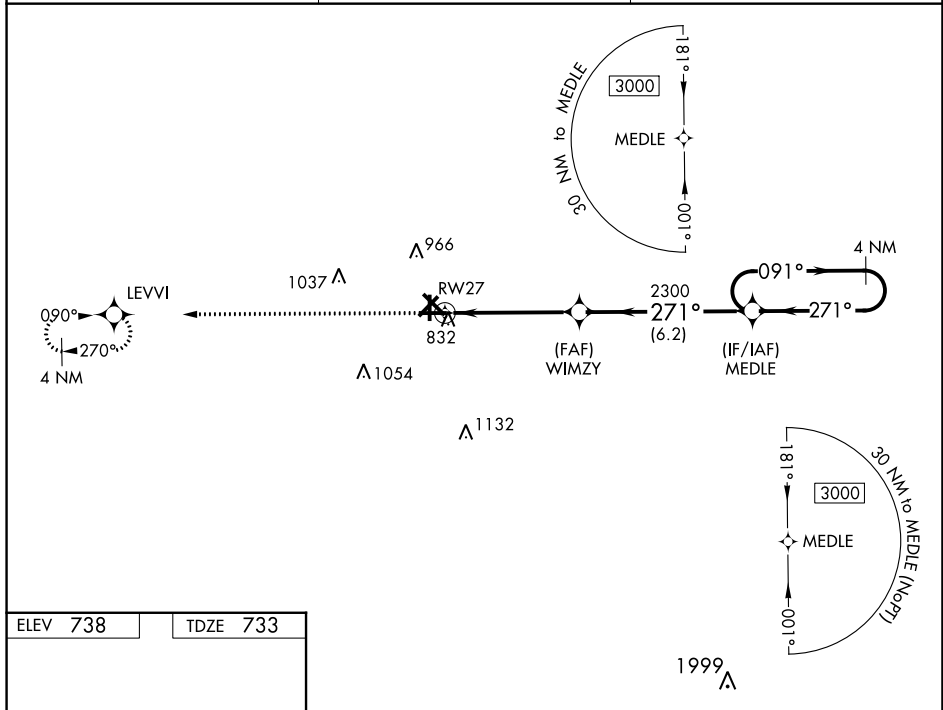

ELEV 738	TDZE 733
-----------------	-----------------

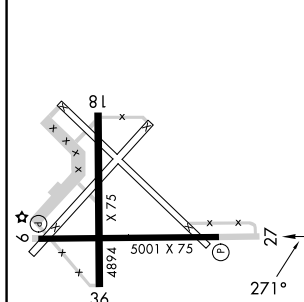

REIL Rwy 9 and 27 **①**
MIRL Rwy 9-27 and 18-36 **①**

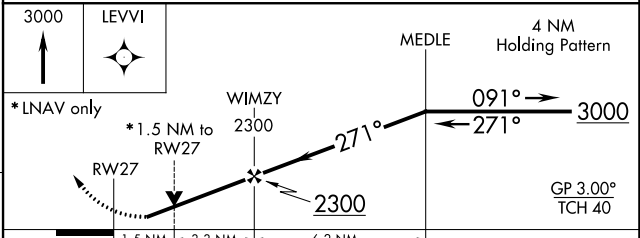

CATEGORY	A	B	C	D
LPV DA	983-1		250 (300-1)	
LNAV/VNAV DA	1029-1		296 (300-1)	
LNAV MDA	1240-1 507 (600-1)		1240-1 3/8 507 (600-1 3/8)	
① CIRCLING	1240-1 502 (600-1)	1280-1 542 (600-1)	1380-1 3/4 642 (700-1 3/4)	1420-2 1/4 682 (700-2 1/4)

EC-3, 22 FEB 2024 to 21 MAR 2024

EC-3, 22 FEB 2024 to 21 MAR 2024

WAAS CH 61137 W36A	APP CRS 001°	Rwy ldg TDZE 736 Apt Elev 738	4894
--	------------------------	---	-------------

RNAV (GPS) RWY 36

RANTOUL NTL AVN CNTR-FRANK ELLIOTT FLD (TIP)

⚠ Baro-VNAV NA when using Champaign Urbana altimeter setting. For uncompensated Baro-VNAV systems, LNAV/VNAV NA below -1.6°C (4°F) or above 54°C (130°F). DME/DME RNP-0.3 NA. When local altimeter setting not received, use Champaign Urbana altimeter setting and increase all DA 41 feet and all MDA 60 feet; increase LNAV/VNAV all Cats visibility 1/8 mile and Circling Cats C/D visibility 1/4 mile. Helicopter visibility reduction below 3/4 SM NA.

MISSED APPROACH:
Climb to 3000 direct
ALADE and hold.

AWOS-3 119.025	CHAMPAIGN APP CON ★ 121.35 285.65	UNICOM 123.0 (CTAF) 0
--------------------------	---	---------------------------------

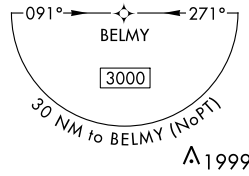
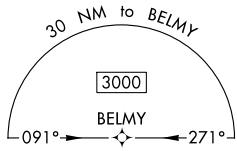
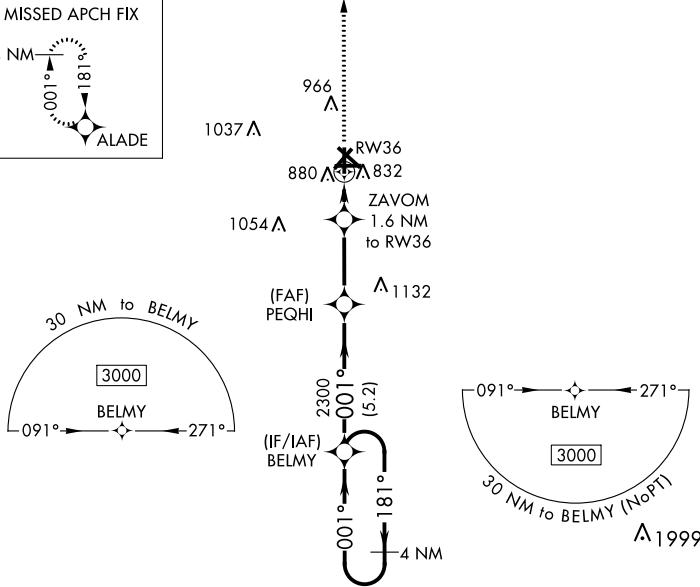
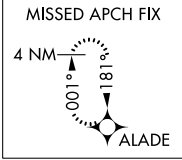

ELEV 738	TDZE 736
-----------------	-----------------

REIL Rwy 9 and 27 **0**
MIRL Rwy 9-27 and 18-36 **0**

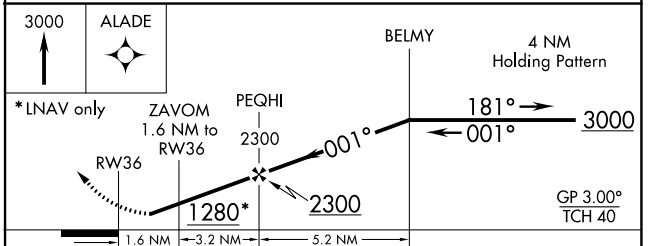
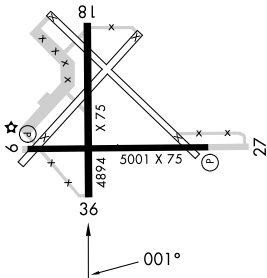

CATEGORY	A	B	C	D
LPV DA	986-1 250 (300-1)			
LNAV/VNAV DA	1147-1 3/8 411 (500-1 3/8)			
LNAV MDA	1140-1 404 (500-1)		1140-1 3/8 404 (500-1 3/8)	
C CIRCLING	1220-1 482 (500-1)	1280-1 542 (600-1)	1380-1 3/4 642 (700-1 3/4)	1420-2 1/4 682 (700-2 1/4)

WAAS CH 62937 W09A	APP CRS 091°	Rwy Idg TDZE 735 Apt Elev 738	5001
--	------------------------	---	-------------

RNAV (GPS) RWY 9

RANTOUL NTL AVN CNTR-FRANK ELLIOTT FLD (TIP)

⚠ For uncompensated Baro-VNAV systems, LNAV/VNAV NA below -16°C (4°F) or above 54°C (130°F). DME/DME RNP-0.3 NA. When local altimeter setting not received, use Champaign Urbana altimeter setting and increase DA 41 feet and all MDA 60 feet; increase LNAV/VNAV all Cats and LNAV Cats C/D visibility 1/8 mile and Circling Cats C/D visibility 1/4 mile. Baro-VNAV and VDP NA when using Champaign Urbana altimeter setting. Helicopter visibility reduction below 3/4 SM NA.

MISSED APPROACH:
Climb to 3000 direct MEDLE and hold.

AWOS-3
119.025

CHAMPAIGN APP CON ★
121.35 285.65

UNICOM
123.0 (CTAF) ①

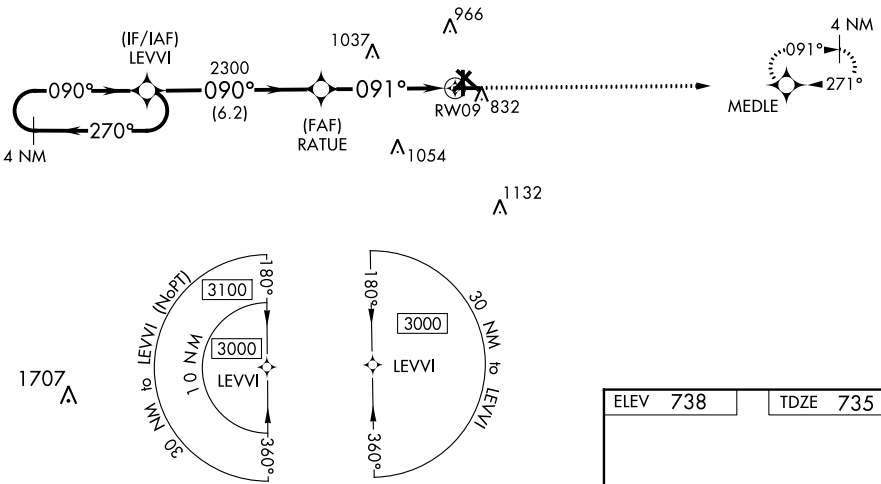

EC-3, 22 FEB 2024 to 21 MAR 2024

EC-3, 22 FEB 2024 to 21 MAR 2024

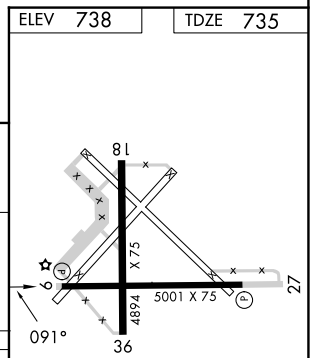
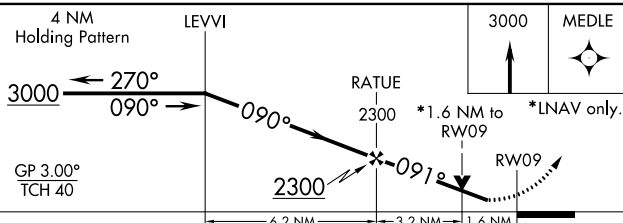

CATEGORY	A	B	C	D
LPV DA	985-1		250 (300-1)	
LNAV/VNAV DA	1167-1½		432 (500-1½)	
LNAV MDA	1280-1	545 (600-1)	1280-1½	545 (600-1½)
C CIRCLING	1280-1	542 (600-1)	1380-1¾ 642 (700-1¾)	1420-2¼ 682 (700-2¼)

REIL Rwy 9 and 27 ①
MIRL Rwy 9-27 and 18-36 ①

INSTRUMENT APPROACH PROCEDURE CHARTS

A IFR ALTERNATE AIRPORT MINIMUMS

Pilots must review the IFR Alternate Minimums Notes to determine alternate airport suitability.

ANA designation on the approach chart means that pilots may not use that approach as an alternate due to unmonitored facility, absence of weather reporting service, or lack of adequate navigation coverage. Approaches with the **A**NA designation are not listed in this section. **A** designation on the approach chart indicates that the approach procedure has non-standard minimums (for aircraft other than helicopters) or restrictions (for all users) for its use as an alternate.

Alternate Minima (ref: 14 CFR 91.169)

	Precision Approach	Non-Precision Approach
Standard	600-2	800-2
A Non-Standard or restrictions	As indicated below	As indicated below
Helicopters	For the selected approach: Ceiling: 200' above published ceiling Visibility: the greater of 1 SM visibility or the published visibility	
US Military (USA/USN/USAF)	See Service Regulations	

Note: For alternate airport flight planning purposes, precision approach operations include: ILS, PAR, and GLS, and Non-Precision approach operations include: NDB, VOR, LOC, TACAN, LDA, SDF, ASR, RNAV (GPS) and RNAV (RNP).

NAME ALTERNATE MINIMUMS

ALTON/ST. LOUIS, IL

ST. LOUIS
 RGNL (ALN).....**ILS or LOC Rwy 29¹**
 RNAV (GPS) Rwy 11
 RNAV (GPS) Rwy 17
 RNAV (GPS) Rwy 29
 RNAV (GPS) Rwy 35
 VOR-A

NA when local weather not available.

¹NA when control tower closed.

ANTIGO, WI

LANGLADE
 COUNTY (AIG).....**RNAV (GPS) Rwy 9¹**
 RNAV (GPS) Rwy 17²
 RNAV (GPS) Rwy 27³
 RNAV (GPS) Rwy 35²

¹Categories A, B, C, D, 800-2¼.

²NA when local weather not available.

³Category D, 800-2¼.

APPLETON, WI

APPLETON
 INTL (ATW).....**ILS or LOC Rwy 3¹**
 RNAV (GPS) Rwy 3²
 RNAV (GPS) Rwy 12²
 RNAV (GPS) Rwy 21²

¹NA when control tower closed.

²NA when local weather not available.

NAME ALTERNATE MINIMUMS

ASHLAND, WI

JOHN F KENNEDY
 MEML (ASX).....**RNAV (GPS) Rwy 2**
 RNAV (GPS) Rwy 13
 RNAV (GPS) Rwy 20
 RNAV (GPS) Rwy 31

NA when local weather not available.
Category D, 800-2¼.

BARABOO, WI

BARABOO/WISCONSIN DELLS
 RGNL (DLL).....**RNAV (GPS) Rwy 1**
 RNAV (GPS) Rwy 19
 VOR-A

NA when local weather not available.

22 FEB 2024 to 21 MAR 2024

22 FEB 2024 to 21 MAR 2024

NAME ALTERNATE MINIMUMS

BELLEVILLE, IL

SCOTT AFB/MIDAMERICA ST
 LOUIS (BLV).....**ILS or LOC Rwy 14L¹²**
 ILS or LOC Rwy 14R¹²
 ILS or LOC Rwy 32L¹²
 ILS or LOC Rwy 32R¹²
 RADAR-1³
 RNAV (GPS) Rwy 14L¹⁴
 RNAV (GPS) Rwy 14R¹⁴
 RNAV (GPS) Rwy 32L¹⁴
 RNAV (GPS) Rwy 32R¹⁴
 TACAN-A¹⁵
 TACAN Rwy 14R¹³
 TACAN Rwy 32L¹³

- ¹NA when local weather not available.
- ²LOC, Category C, 800-2¼; Category D, 800-2½; Category E, 800-2¾.
- ³Category C, 800-2¼; Category D, 800-2½; Category E, 800-2¾.
- ⁴Category C, 800-2¼; Category D, 800-2½.
- ⁵Categories A, B, C, 800-2¼; Category D, 800-2½; Category E, 800-2¾.

BLACK RIVER FALLS, WI

BLACK RIVER FALLS
 AREA (BCK).....**RNAV (GPS) Rwy 8**
 RNAV (GPS) Rwy 26
 NA when local weather not available.
 Category D 1000-3.

BLOOMINGTON/NORMAL, IL

CENTRAL IL RGNL/BLOOMINGTON-
 NORMAL (BMI).....**ILS or LOC Rwy 2¹²**
 ILS or LOC Rwy 20¹²
 ILS or LOC Rwy 29¹²
 LOC BC Rwy 11¹³
 RNAV (GPS) Rwy 2³
 RNAV (GPS) Rwy 11³
 RNAV (GPS) Rwy 20³
 RNAV (GPS) Rwy 29³

- NA when local weather not available.
- ¹NA when control tower closed.
- ²LOC, Category C, 800-2¼; Category D, 800-2½.
- ³Category C, 800-2¼; Category D, 800-2½.

BOSCOBEL, WI

BOSCOBEL (OVS).....**RNAV (GPS) Rwy 7¹**
 RNAV (GPS) Rwy 25²
 NA when local weather not available.
¹Category A, 900-2; Category B, 1000-2;
 Category C, 1000-2¾.
²Categories A, B, 1000-4; Category C, 1100-4.

BURLINGTON, WI

BURLINGTON
 MUNI (BUU).....**RNAV (GPS) Rwy 11**
 RNAV (GPS) Rwy 29
 VOR-A
 NA when local weather not available.
 Category D, 800-2½.

NAME ALTERNATE MINIMUMS

CAHOKIA/ST. LOUIS, IL

ST. LOUIS
 DOWNTOWN (CPS).....**ILS or LOC Rwy 30L¹²**
 RNAV (GPS) Rwy 12R³
 RNAV (GPS) Rwy 30L³
 RNAV (GPS) Rwy 30R³

- NA when local weather not available.
- ¹NA when control tower closed.
- ²LOC, Category C, 900-2½; Category D, 1000-3.
- ³Category C, 900-2½; Category D, 1000-3.

CAIRO, IL

CAIRO RGNL (CIR).....**RNAV (GPS) Rwy 14**
 RNAV (GPS) Rwy 32
 NA when local weather not available.

CARBONDALE/MURPHYSBORO, IL

SOUTHERN
 ILLINOIS (MDH).....**ILS or LOC Rwy 18L¹²**
 NDB Rwy 18L¹³
 RNAV (GPS) Rwy 18L³
 RNAV (GPS) Rwy 36R³

- NA when local weather not available.
- ¹NA when control tower closed.
- ²LOC, Category C, 800-2¼; Category D, 800-2½.
- ³Category C, 800-2¼; Category D, 800-2½.

CARMI, IL

CARMI MUNI (CUL).....**RNAV (GPS) Rwy 18**
 RNAV (GPS) Rwy 36
 NA when local weather not available.

CHAMPAIGN/URBANA, IL

UNIVERSITY OF ILLINOIS/
 WILLARD (CMI).....**ILS or LOC Rwy 32R^{12,3}**
 NDB Rwy 32R³⁴
 RADAR-1¹⁴
 RNAV (GPS) Rwy 4³⁴
 RNAV (GPS) Rwy 14L³⁴
 RNAV (GPS) Rwy 22³⁴
 RNAV (GPS) Rwy 32R³⁴
 VOR Rwy 4⁴
 VOR Rwy 14L⁴
 VOR Rwy 22³⁴

- ¹NA when control tower closed.
- ²LOC, Category C, 800-2¼; Category D, 800-2½.
- ³NA when local weather not available.
- ⁴Category C, 800-2¼; Category D, 800-2½.

CHETEK, WI

CHETEK MUNI/
 SOUTHWORTH (Y23).....**RNAV (GPS) Rwy 17**
 NA when local weather not available.

22 FEB 2024 to 21 MAR 2024

22 FEB 2024 to 21 MAR 2024

NAME ALTERNATE MINIMUMS

CHICAGO, IL

CHICAGO MIDWAY
INTL (MDW).....ILS or LOC Rwy 4R¹
 ILS or LOC Rwy 13C¹
 ILS or LOC Rwy 31C¹
 RNAV (GPS) Rwy 4L²
 RNAV (GPS) Rwy 22R²
 RNAV (GPS) Rwy 31R²
 RNAV (GPS) Z Rwy 4R²
 RNAV (GPS) Z Rwy 13C²
 RNAV (GPS) Z Rwy 22L²
 RNAV (GPS) Z Rwy 31C²

¹LOC, Category D, 800-2½.²Category D, 800-2¼.**CHICAGO O'HARE**

INTL (ORD).....ILS or LOC Rwy 4R¹
 ILS or LOC Rwy 22L¹
 ILS or LOC Rwy 22R¹
 RNAV (GPS) Rwy 4R²
 RNAV (GPS) Rwy 22L²
 RNAV (GPS) Rwy 22R²

¹LOC, Category D, 800-2½.²Category D, 800-2¼.

LANSING MUNI (IGQ).....RNAV (GPS) Rwy 27
 RNAV (GPS) Rwy 36
 VOR-A

NA when local weather not available.

**CHICAGO/PROSPECT HEIGHTS/
WHEELING, IL**

CHICAGO
EXEC (PWK).....ILS or LOC Rwy 16¹
 RNAV (GPS) Rwy 16²
 RNAV (GPS) Rwy 30²
 VOR Rwy 16²

NA when local weather not available.

¹LOC, Category D, 900-2¾.²Category D, 900-2¼.**CHICAGO/ROCKFORD, IL**

CHICAGO/ROCKFORD
INTL (RFD).....ILS or LOC Rwy 1²
 ILS or LOC Rwy 7²
 LOC BC Rwy 19¹²
 RNAV (GPS) Rwy 1³
 RNAV (GPS) Rwy 7³
 RNAV (GPS) Rwy 19³
 RNAV (GPS) Rwy 25³

¹NA when local weather not available.²LOC, Category D, 800-2¼.³Category D, 800-2¼.

NAME ALTERNATE MINIMUMS

CHICAGO/ROMEOVILLE, IL

LEWIS
UNIVERSITY (LOT).....RNAV (GPS) Rwy 2
 RNAV (GPS) Rwy 9
 RNAV (GPS) Rwy 20
 RNAV (GPS) Rwy 27

NA when local weather not available.

Category C, 800-2¼; Category D, 800-2½.

CHICAGO/WAUKEGAN, IL

WAUKEGAN
NTL (UGN).....ILS or LOC Rwy 23¹²
 RNAV (GPS) Rwy 5³⁴
 RNAV (GPS) Rwy 23³

¹NA when control tower closed.²ILS, Category D, 700-2¼; LOC, Category D, 800-2¼.³Category D, 800-2¼.⁴NA when local weather not available.**CHICAGO/WEST CHICAGO, IL**

DUPAGE (DPA).....ILS or LOC Rwy 12¹²
 ILS or LOC Rwy 10³⁴
 RNAV (GPS) Rwy 2L¹⁵
 RNAV (GPS) Rwy 2R¹⁵
 RNAV (GPS) Rwy 10¹⁵
 RNAV (GPS) Rwy 20L¹⁵
 RNAV (GPS) Rwy 20R¹⁵

¹NA when local weather not available.²ILS, Categories A, B, 800-2; Category C, 800-2¼; Category D, 800-2½; LOC, Category C, 800-2¼; Category D, 800-2½.³LOC, NA when local weather not available.⁴LOC, Category D, 800-2¼.⁵Category D, 800-2¼.**CLINTONVILLE, WI**

CLINTONVILLE
MUNI (CLI).....RNAV (GPS) Rwy 22
NA when local weather not available.

CUMBERLAND, WI

CUMBERLAND
MUNI (UBE).....RNAV (GPS) Rwy 9
 RNAV (GPS) Rwy 27
NA when local weather not available.
Category D, 800-2¼.

DANVILLE, IL

VERMILION
RGNL (DNV).....RNAV (GPS) Rwy 3
 RNAV (GPS) Rwy 21
 RNAV (GPS) Rwy 34

NA when local weather not available.

NAME ALTERNATE MINIMUMS

DE KALB, IL

DE KALB TAYLOR
MUNI (DKB)..... ILS or LOC Rwy 2¹
RNAV (GPS) Rwy 2²
RNAV (GPS) Rwy 9²
RNAV (GPS) Rwy 20²
RNAV (GPS) Rwy 27²

NA when local weather not available.

¹LOC, Categories A, B, 1000-2,

Categories C, D 1000-3.

²Category D, 900-2¼.

DECATUR, IL

DECATUR (DEC)..... ILS or LOC Rwy 6¹²³
LOC BC Rwy 24⁴⁵⁶
RNAV (GPS) Rwy 6¹⁶
RNAV (GPS) Rwy 12¹⁶
RNAV (GPS) Rwy 18¹⁶
RNAV (GPS) Rwy 24¹⁶
RNAV (GPS) Rwy 30⁵⁶
RNAV (GPS) Rwy 36⁵⁶
VOR Rwy 18¹
VOR Rwy 36⁵⁶

¹NA when local weather not available.

²ILS, LOC, NA when control tower closed, except for operators with approved weather reporting services.

³LOC, Category D, 800-2¼.

⁴NA when control tower closed.

⁵NA when local weather not available, except for operators with approved weather reporting services.

⁶Category D, 800-2¼.

EAGLE RIVER, WI

EAGLE RIVER
UNION (EGV)..... RNAV (GPS) Rwy 4
RNAV (GPS) Rwy 22
VOR/DME Rwy 4

NA when local weather not available.

Category D, 800-2¼.

EAU CLAIRE, WI

CHIPPEWA VALLEY
RGNL (EAU)..... ILS or LOC Rwy 22¹
LOC BC Rwy 4²
RNAV (GPS) Rwy 4²
RNAV (GPS) Rwy 22²
VOR-A³

NA when local weather not available.

¹LOC, Category C, 800-2¼, Category D, 1300-3.

²Category C, 800-2¼; Category D, 1300-3.

³Categories A, B, 900-2; Category C, 900-2¼; Category D, 1300-3.

NAME ALTERNATE MINIMUMS

EFFINGHAM, IL

EFFINGHAM COUNTY
MEML (1H2)..... RNAV (GPS) Rwy 11²
RNAV (GPS) Rwy 11³
RNAV (GPS) Rwy 29¹

¹NA when local weather not available.

²Category C, 900-2¼.

³Category C, 900-2¼; Category D, 900-2¼.

EPHRAIM, WI

EPHRIAM/
GIBRALTAR (3D2)..... RNAV (GPS) Rwy 14
RNAV (GPS) Rwy 32

NA when local weather not available.

FAIRFIELD, IL

FAIRFIELD MUNI (FWC)..... NDB Rwy 9
NA when local weather not available.

FLORA, IL

FLORA MUNI (FOA)..... RNAV (GPS) Rwy 3
RNAV (GPS) Rwy 21

NA when local weather not available.

FOND DU LAC, WI

FOND DU LAC
COUNTY (FLD)..... RNAV (GPS) Rwy 18
RNAV (GPS) Rwy 36
VOR Rwy 18
VOR/DME Rwy 36

NA when local weather not available.

Category D, 800-2¼.

FREEPORT, IL

ALBERTUS (FEP)..... RNAV (GPS) Rwy 6
RNAV (GPS) Rwy 24

NA when local weather not available.

Category D, 800-2¼.

GALESBURG, IL

GALESBURG
MUNI (GBG)..... RNAV (GPS) Rwy 3
RNAV (GPS) Rwy 21

NA when local weather not available.

Category D, 900-2¼.

GREEN BAY, WI

GREEN BAY/AUSTIN STRAUBEL
INTL (GRB)..... ILS or LOC Rwy 6
LOC BC Rwy 24
RADAR-1

NA when control tower closed.

HARRISBURG, IL

HARRISBURG-
RALEIGH (HSB)..... RNAV (GPS) Rwy 6
RNAV (GPS) Rwy 24

NA when local weather not available.

Category D, 800-2¼.

NAME ALTERNATE MINIMUMS

HAYWARD, WI

SAWYER
COUNTY (HYR)..... RNAV (GPS) Rwy 3
RNAV (GPS) Rwy 21
NA when local weather not available.
Category C, 900-2½; Category D, 900-2¾.

JACKSONVILLE, IL

JACKSONVILLE
MUNI (IJX)..... RNAV (GPS) Rwy 4
RNAV (GPS) Rwy 13
RNAV (GPS) Rwy 22
RNAV (GPS) Rwy 31
NA when local weather not available.
Category D, 800-2¼.

JANESVILLE, WI

SOUTHERN WISCONSIN
RGNL (JVL)..... ILS or LOC Rwy 4¹
ILS or LOC Rwy 32¹
RNAV (GPS) Rwy 4
RNAV (GPS) Rwy 14
RNAV (GPS) Rwy 22
NA when local weather not available.
¹NA when control tower closed.

JUNEAU, WI

DODGE COUNTY (UNU)..... RNAV (GPS) Rwy 2
RNAV (GPS) Rwy 8
RNAV (GPS) Rwy 20
RNAV (GPS) Rwy 26
NA when local weather not available.

KANKAKEE, IL

GREATER
KANKAKEE (IKK)..... ILS or LOC Rwy 4¹²
RNAV (GPS) Rwy 4³⁴
RNAV (GPS) Rwy 16³⁴
RNAV (GPS) Rwy 22³⁴
RNAV (GPS) Rwy 34³
¹LOC, NA when local weather not available.
²LOC, Category D, 800-2¼.
³NA when local weather not available.
⁴Category D, 800-2¼.

KENOSHA, WI

KENOSHA
RGNL (ENW)..... ILS or LOC Rwy 7L¹²
RNAV (GPS) Rwy 7L³
RNAV (GPS) Rwy 15³
RNAV (GPS) Rwy 25R³
RNAV (GPS) Rwy 33³
NA when local weather not available.
¹NA when control tower closed.
²LOC, Category D, 800-2¼.
³Category D, 800-2¼.

NAME ALTERNATE MINIMUMS

LA CROSSE, WI

LA CROSSE
RGNL (LSE)..... ILS or LOC Rwy 18¹²
RNAV (GPS) Rwy 4³⁴
RNAV (GPS) Rwy 13³⁵
RNAV (GPS) Rwy 18³⁵
RNAV (GPS) Rwy 22³⁶
RNAV (GPS) Rwy 31³⁷
RNAV (GPS) Rwy 36³⁵

¹NA when control tower closed.
²LOC, Categories A, B, 1000-2, Categories C, D, 1200-3.
³NA when local weather not available.
⁴Categories A, B, 1000-2; Categories C, D, 1200-3.
⁵Category B, 900-2; Categories C, D, 1200-3.
⁶Categories A, B, 1200-2; Categories C, D, 1200-3.
⁷Categories A, B, 1100-2; Categories C, D, 1200-3.

LA POINTE, WI

MAJOR GILBERT
FLD (4R5)..... RNAV (GPS) Rwy 4
NA when local weather not available.

LACON, IL

MARSHALL
COUNTY (C75)..... RNAV (GPS) Rwy 13
VOR Rwy 13
NA when local weather not available.

LADYSMITH, WI

RUSK COUNTY (RCX)..... RNAV (GPS) Rwy 14
RNAV (GPS) Rwy 32
NA when local weather not available.

LAND O'LAKES, WI

KING'S LAND
O'LAKES (LNL)..... RNAV (GPS) Rwy 14
RNAV (GPS) Rwy 32
NA when local weather not available.

LAWRENCEVILLE, IL

LAWRENCEVILLE-VINCENNES
INTL (LWV)..... RNAV (GPS) Rwy 9
RNAV (GPS) Rwy 18
RNAV (GPS) Rwy 27
RNAV (GPS) Rwy 36
NA when local weather not available.
Category D, 800-2¼.

LINCOLN, IL

LOGAN COUNTY (AAA)..... RNAV (GPS) Rwy 3
RNAV (GPS) Rwy 21
VOR Rwy 3¹
NA when local weather not available.
¹Category D, 800-2¼.

22 FEB 2024 to 21 MAR 2024

22 FEB 2024 to 21 MAR 2024

NAME ALTERNATE MINIMUMS

LITCHFIELD, IL

LITCHFIELD
MUNI (3LF).....RNAV (GPS) Rwy 9
RNAV (GPS) Rwy 18
RNAV (GPS) Rwy 27
RNAV (GPS) Rwy 36

NA when local weather not available.

LONE ROCK, WI

TRI-COUNTY
RGNL (LNR).....RNAV (GPS) Rwy 9¹
RNAV (GPS) Rwy 27²

NA when local weather not available.

¹Categories A, B, C, 1000-4.

²Categories A, B, C, 900-4.

MACOMB, IL

MACOMB
MUNI (MQB).....RNAV (GPS) Rwy 9
RNAV (GPS) Rwy 27

NA when local weather not available.

Category C, 900-2½; Category D, 900-2¾.

MADISON, WI

DANE COUNTY RGNL/
TRUAX FLD (MSN).....ILS or LOC Rwy 18¹²
ILS or LOC Rwy 21¹³
ILS or LOC/DME Rwy 36¹⁴
RNAV (GPS) Rwy 3⁵
RNAV (GPS) Rwy 14⁵
RNAV (GPS) Rwy 18⁵
RNAV (GPS) Rwy 21⁵
RNAV (GPS) Rwy 32⁵
RNAV (GPS) Rwy 36⁵
VOR Rwy 14⁵
VOR Rwy 32⁵

¹NA when control tower closed.

²LOC, Category D, 900-2¾; Category E, 900-3.

³ILS, LOC, Category D, 900-2¾.

⁴ILS, LOC, Category D, 900-2¾; Category E, 900-3.

⁵Category D, 900-2¾.

MANITOWOC, WI

MANITOWOC
COUNTY (MTW).....ILS or LOC Rwy 17¹
RNAV (GPS) Rwy 17²
RNAV (GPS) Rwy 35²

NA when local weather not available.

¹LOC, Category C, 800-2¼; Category D, 900-2¾.

²Category C, 800-2¼; Category D, 900-2¾.

NAME ALTERNATE MINIMUMS

MARION, IL

VETERANS AIRPORT OF SOUTHERN
ILLINOIS (MWA).....ILS or LOC Rwy 20¹²
RNAV (GPS) Rwy 2³
RNAV (GPS) Rwy 20³

NA when local weather not available.

¹NA when control tower closed.

²LOC, Category D, 900-2¾.

³Category D, 900-2¾.

MARSHFIELD, WI

MARSHFIELD
MUNI (MFI).....RNAV (GPS) Rwy 5
RNAV (GPS) Rwy 16
RNAV (GPS) Rwy 23
RNAV (GPS) Rwy 34

NA when local weather not available.

Category C, 800-2¼; Category D, 800-2½.

MATTOON/CHARLESTON, IL

COLES COUNTY
MEML (MTO).....RNAV (GPS) Rwy 6
RNAV (GPS) Rwy 11
RNAV (GPS) Rwy 24
RNAV (GPS) Rwy 29

NA when local weather not available.

MEDFORD, WI

TAYLOR
COUNTY (MDZ).....RNAV (GPS) Rwy 9
RNAV (GPS) Rwy 16
RNAV (GPS) Rwy 27
RNAV (GPS) Rwy 34

NA when local weather not available.

Category D, 800-2¼.

MENOMONIE, WI

MENOMONIE MUNI/SCORE
FLD (LUM).....RNAV (GPS) Rwy 9¹
RNAV (GPS) Rwy 27²
VOR/DME Rwy 27¹³

¹Category B, 1000-2; Category C, 1000-2¾.

²Category C, 1000-2¾.

³NA when local weather not available.

MIDDLETON, WI

MIDDLETON MUNI/MOREY
FLD (C29).....RNAV (GPS) Rwy 10
VOR Rwy 28

NA when local weather not available.

MERRILL, WI

MERRILL MUNI (RRL).....RNAV (GPS) Rwy 7
RNAV (GPS) Rwy 25

NA when local weather not available.

22 FEB 2024 to 21 MAR 2024

22 FEB 2024 to 21 MAR 2024

NAME ALTERNATE MINIMUMS

MILWAUKEE, WI

LAWRENCE J
TIMMERMAN (MWC).....LOC Rwy 15L¹
RNAV (GPS) Rwy 4L
RNAV (GPS) Rwy 15L
RNAV (GPS) Rwy 22R

NA when local weather not available.

Category D, 900-2¼.

¹NA when control tower closed.

MINERAL POINT, WI

IOWA
COUNTY (MRJ).....RNAV (GPS) Rwy 4
RNAV (GPS) Rwy 11
RNAV (GPS) Rwy 22
RNAV (GPS) Rwy 29

NA when local weather not available.

MINOCQUA-WOODRUFF, WI

LAKELAND/NOBLE F LEE MEML
FLD (ARV).....RNAV (GPS) Rwy 18
RNAV (GPS) Rwy 28
RNAV (GPS) Rwy 36

NA when local weather not available.

MOLINE, IL

QUAD CITIES
INTL (MLI).....ILS or LOC Rwy 9¹²
ILS or LOC Rwy 27¹²
RNAV (GPS) Rwy 9³
RNAV (GPS) Rwy 13⁴
RNAV (GPS) Rwy 27³
RNAV (GPS) Rwy 31³

NA when local weather not available.

¹NA when control tower closed.

²LOC, Category D, 900-2¼.

³Category D, 900-2¼.

⁴Categories A, B, C 800-2½; Category D, 900-2¼.

MONROE, WI

MONROE MUNI (EFT).....RNAV (GPS) Rwy 12
RNAV (GPS) Rwy 30
VOR/DME Rwy 30

NA when local weather not available.

MORRIS, IL

MORRIS MUNI - JAMES R WASHBURN
FLD (C09).....RNAV (GPS) Rwy 18
RNAV (GPS) Rwy 36

NA when local weather not available.

MOSINEE, WI

CENTRAL
WISCONSIN (CWA).....ILS or LOC Rwy 8¹²
ILS or LOC Rwy 35²
RNAV (GPS) Rwy 8¹
RNAV (GPS) Rwy 17¹
RNAV (GPS) Rwy 26¹

¹NA when local weather not available.

²NA when control tower closed.

NAME ALTERNATE MINIMUMS

MOUNT STERLING, IL

MOUNT STERLING
MUNI (I63).....RNAV (GPS) Rwy 18
RNAV (GPS) Rwy 36

NA when local weather not available.

MOUNT VERNON, IL

MOUNT VERNON
(MVN).....ILS or LOC Rwy 23¹
RNAV (GPS) Rwy 5²
RNAV (GPS) Rwy 23²

NA when local weather not available.

¹LOC, Category D, 900-3.

²Category D, 900-3.

NEW RICHMOND, WI

NEW RICHMOND
RGNL (RNH).....RNAV (GPS) Rwy 14
RNAV (GPS) Rwy 32

NA when local weather not available.

OCONTO, WI

OCONTO/J DOUGLAS BAKE
MUNI (OCQ).....RNAV (GPS) Rwy 11
RNAV (GPS) Rwy 29

NA when local weather not available.

OLNEY-NOBLE, IL

OLNEY-NOBLE (OLY).....LOC Rwy 11
NDB Rwy 4
RNAV (GPS) Rwy 4
RNAV (GPS) Rwy 11

NA when local weather not available.

Category D, 800-2¼.

OSCEOLA, WI

L O SIMENSTAD
MUNI (OEO).....RNAV (GPS) Rwy 10
RNAV (GPS) Rwy 28

NA when local weather not available.

OSHKOSH, WI

WITTMAN
RGNL (OSH).....ILS or LOC Rwy 36¹³
LOC/DME BC Rwy 18¹

RNAV (GPS) Rwy 9

RNAV (GPS) Rwy 18

RNAV (GPS) Rwy 27

RNAV (GPS) Rwy 36

VOR Rwy 9

VOR Rwy 18²

VOR Rwy 27

VOR Rwy 36

NA when local weather not available.

¹NA when control tower closed.

²Category D, 800-2¼.

³ILS, Category D, 700-2.

NAME ALTERNATE MINIMUMS

PARIS, IL

EDGAR COUNTY (PRG).....RNAV (GPS) Rwy 9
 RNAV (GPS) Rwy 18
 RNAV (GPS) Rwy 27
 RNAV (GPS) Rwy 36

NA when local weather not available.

PEORIA, IL

GENERAL DOWNING-

PEORIA INTL (PIA).....ILS or LOC Rwy 4¹
 ILS or LOC Rwy 13²
 ILS or LOC Rwy 31¹
 NDB Rwy 31³
 RNAV (GPS) Rwy 4³
 RNAV (GPS) Rwy 13³
 RNAV (GPS) Rwy 22³
 RNAV (GPS) Rwy 31³
 VOR or TACAN Rwy 13³
 VOR/DME or TACAN Rwy 31

NA when local weather not available.

¹LOC, Category D, 800-2 $\frac{1}{4}$.²ILS, LOC, Category D, 800-2 $\frac{1}{4}$.³Category D, 800-2 $\frac{1}{4}$.**PERU, IL**

ILLINOIS VALLEY RGNL-WALTER A

DUNCAN FLD (VYS).....RNAV (GPS) Rwy 18
 RNAV (GPS) Rwy 36

NA when local weather not available.

Category D, 900-2 $\frac{1}{4}$.**PHILLIPS, WI**

PRICE COUNTY (PBH).....RNAV (GPS) Rwy 1
 RNAV (GPS) Rwy 6
 RNAV (GPS) Rwy 19
 RNAV (GPS) Rwy 24

NA when local weather not available.

Category D, 800-2 $\frac{1}{4}$.**PLATTEVILLE, WI**

PLATTEVILLE

MUNI (PVB).....RNAV (GPS) Rwy 15
 RNAV (GPS) Rwy 33

NA when local weather not available.

PONTIAC, IL

PONTIAC MUNI (PNT).....RNAV (GPS) Rwy 6
 RNAV (GPS) Rwy 24
 VOR Rwy 24

NA when local weather not available.

PRAIRIE DU CHIEN, WI

PRAIRIE DU

CHIEN MUNI (PDC).....RNAV (GPS) Rwy 14
 RNAV (GPS) Rwy 29
 RNAV (GPS) Rwy 32

Category A, 1000-2; Category B, 1100-2;

Categories C, D, 1200-3.

NAME ALTERNATE MINIMUMS

QUINCY, IL

QUINCY RGNL-
 BALDWIN FLD (UIN).....RNAV (GPS) Rwy 4
 RNAV (GPS) Rwy 13
 RNAV (GPS) Rwy 22
 RNAV (GPS) Rwy 31

NA when local weather not available.

RACINE, WI

BATTEN

INTL (RAC).....ILS or LOC Rwy 4¹
 RNAV (GPS) Rwy 4²
 RNAV (GPS) Rwy 22²
 RNAV (GPS) Rwy 32²

NA when local weather not available.

¹LOC, Category D, 800-2 $\frac{1}{4}$.²Category D, 800-2 $\frac{1}{4}$.**RANTOUL, IL**

RANTOUL NTL AVN CNTR-FRANK ELLIOTT

FLD (TIP).....RNAV (GPS) Rwy 9
 RNAV (GPS) Rwy 18
 RNAV (GPS) Rwy 27
 RNAV (GPS) Rwy 36

NA when local weather not available.

Category D, 800-2 $\frac{1}{4}$.**REEDSBURG, WI**

REEDSBURG MUNI (C35).....RNAV (GPS) Rwy 36
 NA when local weather not available.

RHINELANDER, WI

RHINELANDER/ONEIDA

COUNTY (RHI).....RNAV (GPS) Rwy 9
 RNAV (GPS) Rwy 15
 RNAV (GPS) Rwy 27
 RNAV (GPS) Rwy 33

NA when local weather not available.

RICE LAKE, WI

RICE LAKE RGNL/

CARL'S FLD (RPD).....ILS or LOC Rwy 1¹²
 RNAV (GPS) Rwy 1¹
 RNAV (GPS) Rwy 19³

¹NA when local weather not available.²LOC, Category D, 900-2 $\frac{1}{4}$.³Category D, 900-2 $\frac{1}{4}$.**ROBINSON, IL**

CRAWFORD COUNTY (RSV).....NDB Rwy 1¹
 RNAV (GPS) Rwy 9²
 RNAV (GPS) Rwy 17
 RNAV (GPS) Rwy 27¹

NA when local weather not available.

¹Category D, 800-2 $\frac{1}{4}$.²Categories A, B, C, D, 800-2 $\frac{1}{2}$.

NAME ALTERNATE MINIMUMS

ROCHELLE, IL
ROCHELLE MUNI/KORITZ
FLD (RPJ).....**RNAV (GPS) Rwy 7**
RNAV (GPS) Rwy 25

NA when local weather not available.
Category C, 900-2¼; Category D, 1100-3.

SALEM, IL

SALEM-
LECKRONE (SLO).....**RNAV (GPS) Rwy 18**
RNAV (GPS) Rwy 36

Category C, 900-2¼; Category D, 900-2½.

SAVANNA, IL

TRI-TOWNSHIP (SFY).....**RNAV (GPS) Rwy 13**
NA when local weather not available.

SHAWANO, WI

SHAWANO
MUNI (EZS).....**RNAV (GPS) Rwy 12**
RNAV (GPS) Rwy 30

NA when local weather not available.
Category C, 900-2¼; Category D, 900-2½.

SHEBOYGAN, WI

SHEBOYGAN COUNTY
MEML (SBM).....**RNAV (GPS) Rwy 22**
NA when local weather not available.

SIREN, WI

BURNETT
COUNTY (RZN).....**RNAV (GPS) Rwy 5**
RNAV (GPS) Rwy 14
RNAV (GPS) Rwy 23
RNAV (GPS) Rwy 32

NA when local weather not available
Category D, 800-2¼.

SPARTA, IL

SPARTA COMMUNITY-HUNTER
FLD (SAR).....**RNAV (GPS) Rwy 36**
NA when local weather not available.
Category D, 800-2½.

SPARTA, WI

SPARTA/
FORT MCCOY (CMY).....**NDB Rwy 29¹**
RNAV (GPS) Rwy 11²
RNAV (GPS) Rwy 29²

NA when local weather not available.
¹Category C, 800-2¼.
²Category C, 800-2¼, Category D, 1100-3.

NAME ALTERNATE MINIMUMS

SPRINGFIELD, IL
ABRAHAM LINCOLN
CAPITAL (SPI).....**ILS or LOC Rwy 4¹²**
ILS or LOC Rwy 22³⁴
RADAR-1¹⁴⁵
RNAV (GPS) Rwy 4¹⁶
RNAV (GPS) Rwy 13¹⁶
RNAV (GPS) Rwy 22¹⁶
RNAV (GPS) Rwy 31¹⁶
VOR Rwy 4¹⁶
VOR/DME Rwy 13¹⁶
VOR/DME Rwy 22¹⁶
VOR/DME Rwy 31¹⁶

¹NA when local weather not available.
²ILS, LOC Category C, 800-2¼;
Category D, 800-2½.
³LOC, Category C, 800-2¼; Category D, 800-2½.
⁴NA when control tower closed.
⁵Category C, 800-2¼; Category D, 800-2½;
Category E, 800-2¼.
⁶Category C, 800-2¼; Category D, 800-2½.

STERLING/ROCKFALLS, IL

WHITESIDE COUNTY/JOS H BITTORF
FLD (SQI).....**RNAV (GPS) Rwy 7**
RNAV (GPS) Rwy 25

NA when local weather not available.
Category D, 900-2¼.

STEVENS POINT, WI

STEVENS POINT
MUNI (STE).....**RNAV (GPS) Rwy 3**
RNAV (GPS) Rwy 12
RNAV (GPS) Rwy 21
RNAV (GPS) Rwy 30

NA when local weather not available.
Category C, 800-2¼; Category D, 800-2½.

STURGEON BAY, WI

DOOR COUNTY
CHERRYLAND (SUE).....**RNAV (GPS) Rwy 2**
RNAV (GPS) Rwy 10
RNAV (GPS) Rwy 20
RNAV (GPS) Rwy 28

NA when local weather not available.

SUPERIOR, WI

RICHARD I
BONG (SUW).....**RNAV (GPS) Rwy 4**
RNAV (GPS) Rwy 14
RNAV (GPS) Rwy 22¹
RNAV (GPS) Rwy 32

Category D, 800-2¼.
¹NA when local weather not available.

22 FEB 2024 to 21 MAR 2024

22 FEB 2024 to 21 MAR 2024

24025

NAME ALTERNATE MINIMUMS

TAYLORVILLE, IL

TAYLORVILLE
MUNI (TAZ).....RNAV (GPS) Rwy 18
RNAV (GPS) Rwy 36

NA when local weather not available.

TOMAHAWK, WI

TOMAHAWK
RGNL (TKV).....RNAV (GPS) Rwy 9
RNAV (GPS) Rwy 27

NA when local weather not available.
Category D, 900-2¾.

VANDALIA, IL

VANDALIA
MUNI (VLA).....RNAV (GPS) Rwy 18
RNAV (GPS) Rwy 36

NA when local weather not available.
Category D, 800-2¼.

VIROQUA, WI

VIROQUA MUNI (Y51).....RNAV (GPS) Rwy 11
RNAV (GPS) Rwy 29¹

NA when local weather not available.
¹Category B, 900-2; Category C, 900-2½.

WATERTOWN, WI

WATERTOWN
MUNI (RYV).....RNAV (GPS) Rwy 5¹
RNAV (GPS) Rwy 11²
RNAV (GPS) Rwy 23¹
RNAV (GPS) Rwy 29¹

NA when local weather not available.
¹Category C, 900-2¾; Category D, 900-3.
²Categories A, B, 900-2; Category C, 900-2¾;
Category D, 900-3.

WAUKESHA, WI

WAUKESHA
COUNTY (UES).....ILS or LOC Rwy 10¹²
RNAV (GPS) Rwy 10³
RNAV (GPS) Rwy 28³
VOR-A³

NA when local weather not available.
¹NA when control tower closed.
²LOC, Category D, 800-2¼.
³Category D, 800-2¼.

WAUPACA, WI

WAUPACA
MUNI (PCZ).....RNAV (GPS) Rwy 10

NA when local weather not available.

WAUSAU, WI

WAUSAU
DOWNTOWN (AUW).....RNAV (GPS) Rwy 13¹
RNAV (GPS) Rwy 31²

¹Category C, 800-2¼; Category D, 1100-3.
²Category D, 1100-3.

NAME ALTERNATE MINIMUMS

WAUTOMA, WI

WAUTOMA MUNI (Y50).....RNAV (GPS) Rwy 13
RNAV (GPS) Rwy 31

NA when local weather not available.

WEST BEND, WI

WEST BEND
MUNI (ETB).....RNAV (GPS) Rwy 6
RNAV (GPS) Rwy 13
RNAV (GPS) Rwy 24
RNAV (GPS) Rwy 31
VOR Rwy 13
VOR Rwy 24

NA when local weather not available.
Category D, 800-2¼.

WISCONSIN RAPIDS, WI

ALEXANDER FLD SOUTH WOOD
COUNTY (ISW).....RNAV (GPS) Rwy 2¹
RNAV (GPS) Rwy 20

Category D, 800-2½.
¹NA when local weather not available.

22 FEB 2024 to 21 MAR 2024

22 FEB 2024 to 21 MAR 2024

24025

M10

TAKEOFF MINIMUMS, (OBSTACLE) DEPARTURE PROCEDURES, AND DIVERSE VECTOR AREA (RADAR VECTORS)

23278

INSTRUMENT APPROACH PROCEDURE CHARTS

IFR TAKEOFF MINIMUMS AND (OBSTACLE) DEPARTURE PROCEDURES

Civil Airports and Selected Military Airports

ALL USERS: Airports that have Departure Procedures (DPs) designed specifically to assist pilots in avoiding obstacles during the climb to the minimum enroute altitude, and/or airports that have civil IFR takeoff minimums other than standard, are listed below. Takeoff Minimums and Departure Procedures apply to all runways unless otherwise specified. An entry may also be listed that contains only Takeoff Obstacle Notes. Altitudes, unless otherwise indicated, are minimum altitudes in MSL.

DPs specifically designed for obstacle avoidance are referred to as Obstacle Departure Procedures (ODPs) and are textually described below, or published separately as a graphic procedure. If the ODP is published as a graphic procedure, its name will be listed below, and it can be found in either this volume (civil), or the applicable military volume, as appropriate. Users will recognize graphic obstacle DPs by the term "(OBSTACLE)" included in the procedure title; e.g., TETON TWO (OBSTACLE). If not specifically assigned an ODP, SID, or RADAR vector as part of an IFR clearance, an ODP may be required to be flown for obstacle clearance, even though not specifically stated in the IFR clearance. When doing so in this manner, ATC should be informed when the ODP being used contains a specified route to be flown, restrictions before turning, and/or altitude restrictions.

Some ODPs, which are established solely for obstacle avoidance, require a climb in visual conditions to cross the airport, a fix, or a NAVAID in a specified direction, at or above a specified altitude. These procedures are called Visual Climb Over Airport (VCOA). To ensure safe and efficient operations, the pilot must verbally request approval from ATC to fly the VCOA when requesting their IFR clearance.

At some locations where an ODP has been established, a diverse vector area (DVA) may be created to allow RADAR vectors to be used in lieu of an ODP. DVA information will state that headings will be as assigned by ATC and climb gradients, when applicable, will be published immediately following the specified departure procedure.

Graphic DPs designed by ATC to standardize traffic flows, ensure aircraft separation and enhance capacity are referred to as "Standard Instrument Departures (SIDs)". SIDs also provide obstacle clearance and are published under the appropriate airport section. ATC clearance must be received prior to flying a SID.

CIVIL USERS NOTE: Title 14 Code of Federal Regulations Part 91 prescribes standard takeoff rules and establishes takeoff minimums for certain operators as follows: (1) For aircraft, other than helicopters, having two engines or less – one statute mile visibility. (2) For aircraft having more than two engines – one-half statute mile visibility. (3) For helicopters – one-half statute mile visibility. These standard minima apply in the absence of any different minima listed below.

MILITARY USERS NOTE: Civil (nonstandard) takeoff minima are published below. For military takeoff minima, refer to appropriate service directives.

ALTON/ST LOUIS, IL

ST LOUIS RGNL (ALN)

TAKEOFF MINIMUMS AND (OBSTACLE) DEPARTURE PROCEDURES

AMDT 2 05MAY11 (11125) (FAA)

TAKEOFF OBSTACLE NOTES:

Rwy 11, tree and pole beginning 1066' from DER, 668' left of centerline, up to 76' AGL/575' MSL.

Tree 2822' from DER, 933' right of centerline, 100' AGL/629' MSL.

Rwy 17, trees beginning 1063' from DER, 282' left of centerline, up to 67' AGL/606' MSL.

Trees beginning 1321' from DER, 115' right of centerline, up to 100' AGL/621' MSL.

Rwy 29, trees and floodlight on hangar beginning 665' from DER, 472' left of centerline, up to 100' AGL/649' MSL. Trees beginning 1570' from DER, 204' right of centerline, up to 75' AGL/604' MSL.

Rwy 35, trees beginning 1286' from DER, 477' left of centerline, up to 67' AGL/596' MSL.

AMERY, WI

AMERY MUNI (AHH)

TAKEOFF MINIMUMS AND (OBSTACLE) DEPARTURE PROCEDURES

AMDT 1C 27JAN22 (22027) (FAA)

TAKEOFF MINIMUMS:

Rwy 18, 400-1½ or std. w/min. climb of 390' per NM to 1500.

TAKEOFF OBSTACLE NOTES:

Rwy 18, NAVAID 8' from DER, 97' left of centerline, 15' AGL/1089' MSL.

Tree 301' from DER, 480' left of centerline, 100' AGL/1124' MSL.

Tree 410' from DER, 472' left of centerline, 100' AGL/1127' MSL.

Vehicles on road beginning 608' from DER, crossing left and right of centerline, up to 15' AGL/1110' MSL.

Trees beginning 667' from DER, 419' left of centerline, up to 100 AGL/1131' MSL.

Trees beginning 644' from DER, 41' right of centerline, up to 100 AGL/1125' MSL.

Trees, pole, tank beginning 708' from DER, 559' right of centerline, up to 1167' MSL.

Tower 6684' from DER, 2073' left of centerline, 140' AGL/1340' MSL.

Rwy 36, vehicles on road beginning 12' from DER, crossing left and right of centerline, up to 15' AGL/1191' MSL.

Trees beginning 83' from DER, 151' right of centerline, up to 100' AGL/1092' MSL.

Trees beginning 287' from DER, 269' right of centerline, up to 100' AGL/1117' MSL.

Trees beginning 1022' from DER, 22' right of centerline, up to 100' AGL/1151' MSL.

Trees beginning 2295' from DER, 98' right of centerline, up to 100' AGL/1155' MSL.

Trees beginning 2856' from DER, 179' right of centerline, up to 100' AGL/1173' MSL.

CONT

TAKEOFF MINIMUMS, (OBSTACLE) DEPARTURE PROCEDURES, AND DIVERSE VECTOR AREA (RADAR VECTORS)

23278

EC-3

TAKEOFF MINIMUMS, (OBSTACLE) DEPARTURE PROCEDURES, AND DIVERSE VECTOR AREA (RADAR VECTORS)

23278

AMERY, WI (CON'T)

AMERY MUNI (AHH) (CON'T)

Rwy 36 (CON'T), pole and tree 352' from DER, 564' left of centerline, up to 1102' MSL.
Tree 569' from DER, 256' left of centerline, 100' AGL/1118' MSL.
Trees and pole beginning 611' from DER, 396' left of centerline, up to 100' AGL/1149' MSL.
Trees beginning 2093' from DER, 270' left of centerline, up to 100' AGL/1150' MSL.
Trees beginning 3827' from DER, 387' left of centerline, up to 100' AGL/1190' MSL.

ANTIGO, WI

LANGLADE COUNTY (AIG)

TAKEOFF MINIMUMS AND (OBSTACLE) DEPARTURE PROCEDURES

AMDT 1 25JUL13 (13206) (FAA)

TAKEOFF MINIMUMS:

Rwy 9, 300-2¼ or std. w/min. climb gradient of 215' per NM to 1900, or alternatively, with standard takeoff minimums and a normal 200' per NM climb gradient, takeoff must occur no later than 1700' prior to DER.

TAKEOFF OBSTACLE NOTES:

Rwy 9, sign 28' from DER, 124' left of centerline, 1' AGL/1524' MSL.
Fence 207' from DER, 440' right of centerline, 10' AGL/1534' MSL.
Buildings beginning 432' from DER, 486' right of centerline, up to 28' AGL/1552' MSL.
Trees beginning 1073' from DER, 637' left of centerline, up to 64' AGL/1597' MSL.
Trees beginning 1.6 NM from DER, 1895' right of centerline, 100' AGL/1799' MSL.
Rwy 17, vehicles on road beginning 17' from DER, 273' left of centerline, up to 15' AGL/1531' MSL.
Vehicles on road beginning 62' from DER, 247' right of centerline, up to 15' AGL/1529' MSL.
Rwy 27, trees beginning 1032' from DER, 379' right of centerline, up to 73' AGL/1587' MSL.
Pole 1142' from DER, 552' right of centerline, 32' AGL/1546' MSL.
Tree 1784' from DER, 159' right of centerline, 55' AGL/1589' MSL.
Trees beginning 1925' from DER, 2' right of centerline, up to 66' AGL/1580' MSL.
Tree 2043' from DER, 225' left of centerline, 60' AGL/1574' MSL.
Tree 2503' from DER, 63' right of centerline, 71' AGL/1580' MSL.
Rwy 35, sign 226' from DER, 493' left of centerline, 29' AGL/1543' MSL.
Building 623' from DER, 665' left of centerline, 32' AGL/1551' MSL.
Trees beginning 896' from DER, 499' right of centerline, up to 62' AGL/1586' MSL.
Poles beginning 1049' from DER, 448' left of centerline, up to 33' AGL/1557' MSL.
Trees beginning 1463' from DER, 471' left of centerline, up to 63' AGL/1587' MSL.
Trees beginning 2334' from DER, 1108' right of centerline, up to 69' AGL/1598' MSL.

APPLETON, WI

APPLETON INTL (ATW)

TAKEOFF MINIMUMS AND (OBSTACLE) DEPARTURE PROCEDURES

ORIG-A 10DEC15 (15344) (FAA)

TAKEOFF OBSTACLE NOTES:

Rwy 3, antenna on building, 266' from DER, 259' right of centerline, 12' AGL/891' MSL.
Trees beginning 545' from DER, 467' right of centerline, up to 42' AGL/911' MSL.
Rwy 12, tree, 85' from DER, 310' left of centerline, 13' AGL/861' MSL.
Rwy 30, trees beginning 568' from DER, 575' right of centerline, up to 21' AGL/950' MSL.

ASHLAND, WI

JOHN F KENNEDY MEML (ASX)

TAKEOFF MINIMUMS AND (OBSTACLE) DEPARTURE PROCEDURES

AMDT 1 05JUN08 (22083) (FAA)

TAKEOFF OBSTACLE NOTES:

Rwy 2, trees beginning 52' from DER, 209' right of centerline, up to 100' AGL/939' MSL.
Trees beginning 119' from DER, 110' left of centerline, up to 100' AGL/929' MSL.
Antenna 2411' from DER, 920' left of centerline, 117' AGL/926' MSL.
Rwy 13, trees beginning 44' from DER, 161' right of centerline, up to 100' AGL/878' MSL.
Trees beginning 831' from DER, 241' left of centerline, up to 100' AGL/868' MSL.
Rwy 20, truck on road 329' from DER, 576' right of centerline, 15' AGL/844' MSL.
Trees beginning 206' from DER, 229' right of centerline, up to 100' AGL/893' MSL.
Trees beginning 1152' from DER, 295' left of centerline, up to 100' AGL/893' MSL.
Rwy 31, truck on road 65' from DER, 325' right and 331' left of centerline, 15' AGL/844' MSL.
Trees beginning 90' from DER, 172' right of centerline, up to 100' AGL/919' MSL.
Trees beginning 34' from DER, 222' left of centerline, up to 100' AGL/838' MSL.

TAKEOFF MINIMUMS, (OBSTACLE) DEPARTURE PROCEDURES, AND DIVERSE VECTOR AREA (RADAR VECTORS)

23278

EC-3

TAKEOFF MINIMUMS, (OBSTACLE) DEPARTURE PROCEDURES, AND DIVERSE VECTOR AREA (RADAR VECTORS)

23278

BARABOO, WI

BARABOO/WISCONSIN DELLS RGNL (DLL)

TAKEOFF MINIMUMS AND (OBSTACLE) DEPARTURE PROCEDURES

AMDT 1B 20JUN19 (21336) (FAA)

TAKEOFF MINIMUMS:

Rwys 14, 32, NA-Environmental.

DEPARTURE PROCEDURE:

Rwy 19, climb on heading 190° to 1800 before turning left.

TAKEOFF OBSTACLE NOTES:

Rwy 1, electrical system 9' from DER, 85' right of centerline, 4' AGL/969' MSL.

Electrical system and NAVAID beginning 10' from DER, 20' left of centerline, up to 3' AGL/970' MSL.

Trees beginning 19' from DER, 169' right of centerline, up to 975' MSL.

Tree 164' from DER, 180' right of centerline, 980' MSL.

Tree 600' from DER, 570' left of centerline, 1009' MSL.

Tree 1177' from DER, 352' left of centerline, 45' AGL/1015' MSL.

Tree 1216' from DER, 284' right of centerline, 1010' MSL.

Tree 1269' from DER, 617' right of centerline, 1030' MSL.

Tree 1423' from DER, 419' left of centerline, 1027' MSL.

Tree 1636' from DER, 377' right of centerline, 60' AGL/1036' MSL.

Tree 2406' from DER, 314' left of centerline, 1033' MSL.

Trees beginning 2469' from DER, 27' right of centerline, up to 1064' MSL.

Tree 2533' from DER, 327' left of centerline, 1035' MSL.

Tree 2557' from DER, 338' left of centerline, 1036' MSL.

Tree 2675' from DER, 344' left of centerline, 1037' MSL.

Tree 2800' from DER, 370' left of centerline, 1038' MSL.

Tree 3215' from DER, 422' left of centerline, 1051' MSL.

Tree 3757' from DER, 244' right of centerline, 1075' MSL.

Trees beginning 3800' from DER, 4' right of centerline, up to 1084' MSL.

Trees beginning 3867' from DER, 461' right of centerline, up to 1095' MSL.

Tree 3867' from DER, 48' left of centerline, 1064' MSL.

Tree 4532' from DER, 650' right of centerline, 1111' MSL.

Rwy 19, NAVAID and electrical system beginning 9' from DER, 16' left of centerline, up to 2' AGL/979' MSL.

NAVAID and electrical system beginning 9' from DER, 19' right of centerline, up to 2' AGL/979' MSL.

Tree 2055' from DER, 69' right of centerline, 1031' MSL.

BELLEVILLE, IL

SCOTT AFB/MIDAMERICA ST LOUIS (BLV)

TAKEOFF MINIMUMS AND (OBSTACLE) DEPARTURE PROCEDURES

ORIG 29JUL10 (21168) (FAA)

TAKEOFF MINIMUMS:

Rwy 32L, 300-1½ or std. w/min. climb of 250' per NM to 800.

TAKEOFF OBSTACLE NOTES:

Rwy 32L, tree 1.24 NM from DER, 2285' left of centerline, 100' AGL/699' MSL.

Rwy 32R, trees beginning 352' from DER, 198' left of centerline, up to 77' AGL/501' MSL.

Trees beginning 1349' from DER, 439' right of centerline, up to 94' AGL/516' MSL.

BELOIT, WI

BELOIT (44C)

TAKEOFF MINIMUMS AND (OBSTACLE) DEPARTURE PROCEDURES

ORIG 13NOV14 (14317) (FAA)

TAKEOFF OBSTACLE NOTES:

Rwy 7, vehicles on road beginning 11' from DER, left and right of centerline, up to 15' AGL/844' MSL.

Trees beginning 13' from DER, 241' right of centerline, 75' AGL/894' MSL.

Tree 20' from DER, 220' left of centerline, 75' AGL/894' MSL.

Silo 86' from DER, 230' left of centerline, 100' AGL/919' MSL.

Tree 146' from DER, 31' left of centerline, 75' AGL/904' MSL.

Tree 278' from DER, 305' left of centerline, 75' AGL/904' MSL.

Tree 827' from DER, 693' left of centerline, 75' AGL/894' MSL.

Tree 4827' from DER, 1523' right of centerline, 75' AGL/944' MSL.

Rwy 25, trees beginning 47' from DER, 35' right of centerline, 75' AGL/884' MSL.

Tree 180' from DER, 237' left of centerline, 75' AGL/874' MSL.

TAKEOFF MINIMUMS, (OBSTACLE) DEPARTURE PROCEDURES, AND DIVERSE VECTOR AREA (RADAR VECTORS)

23278

EC-3

TAKEOFF MINIMUMS, (OBSTACLE) DEPARTURE PROCEDURES, AND DIVERSE VECTOR AREA (RADAR VECTORS)

23278

BENTON, IL

BENTON MUNI (H96)

TAKEOFF MINIMUMS AND (OBSTACLE) DEPARTURE PROCEDURES

ORIG-A 22APR21 (21112) (FAA)

TAKEOFF MINIMUMS:

Rwy 18, 300-1 or std. w/min. climb of 355' per NM to 700.

TAKEOFF OBSTACLE NOTES:

Rwy 18, lighting 12' from DER, 77' left of centerline, 445' MSL.

General utility 14' from DER, 76' right of centerline, 1' AGL/446' MSL.

Tree 66' from DER, 214' right of centerline, 451' MSL.

Trees beginning 120' from DER, 463' left of centerline, up to 450' MSL.

Tree, terrain, pole, building, vehicle on road beginning 132' from DER, 176' right of centerline, up to 52' AGL/500' MSL.

Tree, pole, vehicle on road, sign beginning 415' from DER, 187' left of centerline, up to 510' MSL.

Tree 1217' from DER, 159' left of centerline, 512' MSL.

Tree, pole beginning 1283' from DER, 51' left of centerline, up to 519' MSL.

Tree, pole beginning 1348' from DER, 38' right of centerline, up to 529' MSL.

Trees beginning 1527' from DER, 440' right of centerline, up to 537' MSL.

Tree, pole, sign beginning 1601' from DER, 12' left of centerline, up to 550' MSL.

Trees beginning 1674' from DER, 28' right of centerline, up to 538' MSL.

Tree, pole beginning 1745' from DER, 119' right of centerline, up to 540' MSL.

Sign, pole, tree beginning 2059' from DER, 74' right of centerline, up to 88' AGL/543' MSL.

Trees beginning 2808' from DER, 49' left of centerline, up to 555' MSL.

Trees beginning 2828' from DER, 543' right of centerline, up to 549' MSL.

Trees beginning 3592' from DER, 1164' left of centerline, up to 556' MSL.

Tank, sign beginning 3617' from DER, 583' right of centerline, up to 146' AGL/596' MSL.

Tank 3807' from DER, 855' right of centerline, 163' AGL/613' MSL.

Tree 4457' from DER, 1678' left of centerline, 100' AGL/557' MSL.

Rwy 36, general utility 14' from DER, 77' right of centerline, 3' AGL/441' MSL.

Tree 36' from DER, 378' right of centerline, 445' MSL.

Tree, fence beginning 92' from DER, 229' left of centerline, up to 11' AGL/450' MSL.

Tree 501' from DER, 546' left of centerline, 513' MSL.

Tree 537' from DER, 313' right of centerline, 455' MSL.

Trees beginning 625' from DER, 393' right of centerline, up to 495' MSL.

Tree 630' from DER, 643' left of centerline, 519' MSL.

Tree, pole beginning 673' from DER, 444' left of centerline, up to 91' AGL/532' MSL.

Tree, pole beginning 877' from DER, 435' right of centerline, up to 506' MSL.

Trees beginning 1117' from DER, 141' right of centerline, up to 512' MSL.

Trees beginning 1407' from DER, 11' left of centerline, up to 105' AGL/543' MSL.

Trees beginning 1530' from DER, 117' right of centerline, up to 515' MSL.

Trees beginning 1868' from DER, 292' right of centerline, up to 516' MSL.

Trees beginning 2096' from DER, 147' right of centerline, up to 531' MSL.

Trees beginning 2130' from DER, 39' right of centerline, up to 533' MSL.

Trees beginning 2227' from DER, 11' right of centerline, up to 537' MSL.

BLACK RIVER FALLS, WI

BLACK RIVER FALLS AREA (BCK)

TAKEOFF MINIMUMS AND (OBSTACLE) DEPARTURE PROCEDURES

AMDT 2 23AUG12 (12236) (FAA)

TAKEOFF MINIMUMS:

Rwy 26, 400-3 or std. w/min. climb of 210' per NM to 1400.

TAKEOFF OBSTACLE NOTES:

Rwy 8, trees 173' from DER, 271' right of centerline, up to 10' AGL/841' MSL.

OL on WSK 300' from DER, 400' left of centerline, 23' AGL/863' MSL.

Vehicle on road, 460' from DER, 606' left of centerline, 15' AGL/852' MSL.

Poles 1100' from DER, left and right of centerline, up to 32' AGL/872' MSL.

Trees beginning 1112' from DER, left and right of centerline, up to 53' AGL/919' MSL.

Rwy 26, vehicle on road, 155' from DER, 440' right of centerline, 15' AGL/ 849' MSL.

Fence 2' from DER, left and right of centerline, 7' AGL/827' MSL.

Trees beginning 16' from DER, left and right of centerline, up to 7' AGL/1219' MSL.

BLOOMINGTON-NORMAL, IL

CENTRAL IL RGNL/BLOOMINGTON-NORMAL (BMI)

TAKEOFF MINIMUMS AND (OBSTACLE) DEPARTURE PROCEDURES

ORIG-A 15OCT15 (21112) (FAA)

DEPARTURE PROCEDURE:

Rwy 20, climb heading 201° to 1400 before turning left.

TAKEOFF OBSTACLE NOTES:

Rwy 2, tower 1639' from DER, 908' right of centerline, 78' AGL/922' MSL.

Rwy 11, trees beginning 2069' from DER, 870' right of centerline, up to 100' AGL/979' MSL.

Rwy 29, vehicle on road 103' from DER, 471' right of centerline, 15' AGL/884' MSL.

Tree 1667' from DER, 462' left of centerline, 100' AGL/979' MSL

TAKEOFF MINIMUMS, (OBSTACLE) DEPARTURE PROCEDURES, AND DIVERSE VECTOR AREA (RADAR VECTORS)

23278

EC-3

22 FEB 2024 to 21 MAR 2024

22 FEB 2024 to 21 MAR 2024

TAKEOFF MINIMUMS, (OBSTACLE) DEPARTURE PROCEDURES, AND DIVERSE VECTOR AREA (RADAR VECTORS)

23278

BOLINGBROOK, IL

BOLINGBROOK'S CLOW INTL (1C5)

TAKEOFF MINIMUMS AND (OBSTACLE) DEPARTURE PROCEDURES

AMDT 1 27APR17 (17117) (FAA)

TAKEOFF OBSTACLE NOTES:

Rwy 18, trees and buildings beginning 38' from DER, 299' left of centerline, up to 100' MSL/755' MSL.

Hangars and trees beginning 55' from DER, 223' right of centerline, up to 100' AGL/750' MSL.

Trees beginning 551' from DER, left and right of centerline, up to 750' MSL.

Rwy 36, trees and buildings beginning 304' from DER, 281' left of centerline, up to 100' AGL/770' MSL.

Vehicle on road 390' from DER, 157' right of centerline, 15' AGL/695' MSL.

Sign 615' from DER, 154' right of centerline, 25' AGL/697' MSL.

BOSCobel, WI

BOSCobel (OVS)

TAKEOFF MINIMUMS AND (OBSTACLE) DEPARTURE PROCEDURES

AMDT 1 25OCT07 (07298) (FAA)

TAKEOFF MINIMUMS:

Rwy 2, 600-3 or std. w/min. climb of 447' per NM to 1300.

Rwy 7, std. w/min. climb of 548' per NM to 1500, or 1200-2½ for climb in visual conditions.

Rwy 20, std. w/min. climb of 672' per NM to 1400 or 1200-2½ for climb in visual conditions.

Rwy 25, std. w/min. climb of 381' per NM to 1300 or 1200-2½ for climb in visual conditions.

DEPARTURE PROCEDURE:

Rwy 2, climb heading 017° to 1300 before turning south.

Rwy 7, climb heading 067° to 1500 before turning south, or for climb in visual conditions, cross Boscobel Airport at or above 1700 before proceeding on course.

Rwy 20, climb heading 197° to 1500 before turning east, or for climb in visual conditions, cross Boscobel Airport at or above 1700 before proceeding on course.

Rwy 25, climb heading 247° to 1500 before proceeding on course, or for climb in visual conditions, cross Boscobel Airport at or above 1700 before proceeding on course.

TAKEOFF OBSTACLE NOTES:

Rwy 2, trees 1.3 NM from DER, 2536' left of centerline, 100' AGL/1118' MSL.

Trees 1.6 NM from DER, 1276' left of centerline, 100' AGL/1127' MSL.

Trees 1750' from DER, 470' left of centerline, 100' AGL/835' MSL.

Rwy 7, trees 1.2 NM from DER, 2270' right of centerline, 100' AGL/1167' MSL.

Trees 1290' from DER, 580' left of centerline, 100' AGL/726' MSL.

Tree 13' from DER, 489' left of centerline, 10' AGL/690' MSL.

Trees 1988' from DER, 250' left of centerline, 40' AGL/738' MSL.

Rwy 20, tower 1.7 NM from DER, 640' right of centerline, 205' AGL/1196' MSL.

Tower 3070' from DER, 865' left of centerline, 100' AGL/790' MSL.

Rwy 25, tree 1.6 NM from DER, 2290' right of centerline, 100' AGL/1137' MSL.

Tree 2.1 NM from DER, 1110' right of centerline, 100' AGL/1066' MSL.

Trees 958' from DER, 478' right of centerline, 40' AGL/737' MSL.

Trees 1165' from DER, 701' left of centerline, 40' AGL/731' MSL.

Tree 1.6 NM from DER, 2290' right of centerline, 100' AGL/1137' MSL.

BOYCEVILLE, WI

BOYCEVILLE MUNI (3T3)

TAKEOFF MINIMUMS AND (OBSTACLE) DEPARTURE PROCEDURES

AMDT 1 15JUN23 (23166) (FAA)

TAKEOFF MINIMUMS:

Rwy 8, std. w/min. climb of 250' per NM to 2600, or 1100-3 for VCOA.

VCOA:

Rwy 8, obtain ATC approval for VCOA when requesting IFR clearance. Climb in visual conditions to cross Boyceville Muni airport at or above 1900 before proceeding on course.

TAKEOFF OBSTACLE NOTES:

Rwy 8, NAVAID 10' from DER, 106' left of centerline, 6' AGL/969' MSL.

Trees beginning 810' from DER, 391' right of centerline, up to 1004' MSL.

Trees beginning 1036' from DER, 508' left of centerline, up to 1013' MSL.

Tree 3011' from DER, 208' right of centerline, 1044' MSL.

Tree 3042' from DER, 1302' right of centerline, 1058' MSL.

Tree 3231' from DER, 1257' right of centerline, 1066' MSL.

Rwy 26, terrain 74' from DER, 241' left of centerline, 955' MSL.

Trees, pole beginning 94' from DER, 3' left of centerline, up to 1025' MSL.

Building 521' from DER, 574' right of centerline, 21' AGL/969' MSL.

Building 657' from DER, 613' right of centerline, 27' AGL/974' MSL.

Trees, tower, pole beginning 991' from DER, 81' right of centerline, up to 997' MSL.

Trees beginning 1260' from DER, 114' right of centerline, up to 1004' MSL.

Trees beginning 1280' from DER, 56' right of centerline, up to 1005' MSL.

Trees beginning 1675' from DER, 24' left of centerline, up to 1026' MSL.

Trees, building spire beginning 1771' from DER, 53' right of centerline, up to 1019' MSL.

Trees beginning 2461' from DER, 146' right of centerline, up to 1020' MSL.

Tree 2540' from DER, 68' right of centerline, 1031' MSL.

Tree 2900' from DER, 1206' right of centerline, 1036' MSL.

CON'T

TAKEOFF MINIMUMS, (OBSTACLE) DEPARTURE PROCEDURES, AND DIVERSE VECTOR AREA (RADAR VECTORS)

23278

EC-3

TAKEOFF MINIMUMS, (OBSTACLE) DEPARTURE PROCEDURES, AND DIVERSE VECTOR AREA (RADAR VECTORS)

23278

BOYCEVILLE, WI (CON'T)

BOYCEVILLE MUNI (3T3) (CON'T)

Rwy 26 (CON'T), trees beginning 1.8 NM from DER, 3389' left of centerline, up to 100' AGL/1249' MSL.

Trees beginning 2 NM from DER, 3521' left of centerline, up to 100' AGL/1278' MSL.

Trees beginning 2 NM from DER, 3823' left of centerline, up to 100' AGL/1285' MSL.

BURLINGTON, WI

BURLINGTON MUNI (BUU)

TAKEOFF MINIMUMS AND (OBSTACLE) DEPARTURE PROCEDURES

AMDT 3 19SEP13 (13262) (FAA)

TAKEOFF MINIMUMS:

Rwys 1,19, NA-Environmental.

Rwy 29, 300-1 or std. w/min. climb of 325' per NM to 1000.

TAKEOFF OBSTACLE NOTES:

Rwy 11, numerous trees beginning 137' from DER, 41' right of centerline, up to 125' AGL/901' MSL.

Building 1438' from DER, 415' right of centerline, 50' AGL/825' MSL.

Vehicle on road, antenna, and buildings beginning 43' from DER, 3' left of centerline, up to 37' AGL/812' MSL.

Numerous trees beginning 227' from DER, 46' left of centerline, up to 72' AGL/847' MSL.

Rwy 29, numerous trees beginning 11' from DER, 77' left of centerline, up to 161' AGL/938' MSL.

Buildings beginning 3568' from DER, 1138' left of centerline, up to 122' AGL/899' MSL.

Numerous trees beginning 177' from DER, 144' right of centerline, up to 37' AGL/812' MSL.

CABLE, WI

CABLE UNION (3CU)

TAKEOFF MINIMUMS AND (OBSTACLE) DEPARTURE PROCEDURES

AMDT 5A 10DEC15 (15344) (FAA)

TAKEOFF MINIMUMS:

Rwys 8, 26, NA - environmental.

Rwy 17, 400-2¼ or std. w/min. climb of 655' per NM to 1900.

Rwy 35, 300-1½ or std. w/min. climb of 316' per NM to 1600.

DEPARTURE PROCEDURE:

Rwy 17, climb heading 167° to 1900 before turning right.

TAKEOFF OBSTACLE NOTES:

Rwy 17, trees beginning 15' from DER, 228' left of centerline, up to 91' AGL/1421' MSL.

Trees beginning 572' from DER, 21' left of centerline, up to 26' AGL/1574' MSL.

Vehicle on road, 636' from DER, on centerline, 15' AGL/1388' MSL.

Trees, fence, road and terrain beginning 18' from DER, 169' right of centerline, up to 100' AGL/1500' MSL.

Trees, terrain and buildings beginning 981' from DER, 9' right of centerline, up to 100' AGL/1720' MSL.

Rwy 35, trees beginning 40' from DER, 157' left of centerline, up to 91' AGL/1427' MSL.

Trees beginning 171' from DER, 48' left of centerline, up to 26' AGL/1368' MSL.

Trees beginning 1938' from DER, 14' left of centerline, up to 100' AGL/1502' MSL.

Trees beginning 13' from DER, 216' right of centerline, up to 64' AGL/1403' MSL.

Trees, pole and buildings beginning 610' from DER, 6' right of centerline, up to 100' AGL/1531' MSL.

CAHOKIA/ST LOUIS, IL

ST LOUIS DOWNTOWN (CPS)

TAKEOFF MINIMUMS AND (OBSTACLE) DEPARTURE PROCEDURES

AMDT 8 23SEP10 (10266) (FAA)

TAKEOFF MINIMUMS:

Rwy 5, 200-1 ¼ or std. with a min. climb of 343' per NM to 700.

Rwy 30L, 400-2½ or std. with a min. climb of 220' per NM to 900, alternatively, with standard takeoff minimums and a normal 200' per NM climb gradient, takeoff must occur no later than 2100' prior to DER.

DEPARTURE PROCEDURE:

Rwy 5, climb on heading 047° to 900 before turning left.

Rwys 12L, 12R, climb on heading 122° to 1000 before turning left.

Rwy 23, climb on heading 227° to 2000 before turning.

Rwys 30L, 30R, climb on heading 302° to 1600 before turning.

TAKEOFF OBSTACLE NOTES:

Rwy 5, obstruction light on transmission tower 1649' from DER, 19' left of centerline, 79' AGL/482' MSL.

Transmission tower 324' from DER, 79' right of centerline, 78' AGL/487' MSL.

Rwy 12L, tree 1629' from DER, 144' left of centerline, 45' AGL/453' MSL.

Rwy 12R, tree 3822' from DER, 20' left of centerline, 94' AGL/509' MSL.

Tree 2082' from DER, 927' right of centerline, 69' AGL/486' MSL.

Rwy 23, multiple trees beginning 815' from DER, 69' left of centerline, up to 56' AGL/470' MSL.

Multiple trees beginning 740' from DER, 4' right of centerline, up to 78' AGL/492' MSL.

Rwy 30L, multiple trees beginning 2510' from DER, 503' left of centerline, up to 107' AGL/521' MSL.

Multiple trees beginning 737' from DER, 32' right of centerline, up to 99' AGL/508' MSL.

TAKEOFF MINIMUMS, (OBSTACLE) DEPARTURE PROCEDURES, AND DIVERSE VECTOR AREA (RADAR VECTORS)

23278

TAKEOFF MINIMUMS, (OBSTACLE) DEPARTURE PROCEDURES, AND DIVERSE VECTOR AREA (RADAR VECTORS)

23278

CAIRO, IL

CAIRO RGNL (CIR)

TAKEOFF MINIMUMS AND (OBSTACLE) DEPARTURE PROCEDURES

AMDT 1 27JUN13 (13178) (FAA)

TAKEOFF OBSTACLE NOTES:

Rwy 2, bushes beginning 14' from DER, left and right of centerline, up to 15' AGL/336' MSL.

Trees beginning 142' from DER, 293' right of centerline, up to 62' AGL/372' MSL.

Poles beginning 298' from DER, 215' right of centerline, up to 43' AGL/343' MSL.

Trees beginning 551' from DER, left and right of centerline, up to 100' AGL/424' MSL.

Rwy 14, light support structure 10' from DER, 56' left of centerline, 1' AGL/321' MSL.

Trees beginning 37' from DER, 413' right of centerline, up to 11' AGL/ 321' MSL.

Trees beginning 44' from DER, 357' left of centerline, up to 39' AGL/ 353' MSL.

Trees beginning 651' from DER, left and right of centerline, up to 105' AGL/ 417' MSL.

Rwy 20, trees beginning 38' from DER, 84' left of centerline, up to 34' AGL/349' MSL.

Tree 39' from DER, 79' right of centerline, up to 8' AGL/323' MSL.

Trees beginning 1600' from DER, left and right of centerline, up to 121' AGL/440' MSL.

Rwy 32, REIL 10' from DER, 91' right of centerline, 1' AGL/ 314' MSL.

Sign 11' from DER, 125' left of centerline, 4' AGL/ 316' MSL.

Trees beginning 257' from DER, 77' right of centerline, up to 41' AGL/ 354' MSL.

Trees beginning 662' from DER, 12' left of centerline, up to 91' AGL/ 403' MSL.

Trees beginning 1093' from DER, left and right of centerline, up to 107' AGL/420' MSL.

CANTON, IL

INGERSOLL (CTK)

TAKEOFF MINIMUMS AND (OBSTACLE) DEPARTURE PROCEDURES

ORIG 31JUL08 (08213) (FAA)

TAKEOFF OBSTACLE NOTES:

Rwy 9, tree 1335' from DER, 772' right of centerline, 100' AGL/749' MSL.

Rwy 36, tree 1162' from DER, 486' right of centerline, 100' AGL/739' MSL.

CARBONDALE/MURPHYSBORO, IL

SOUTHERN ILLINOIS (MDH)

TAKEOFF MINIMUMS AND (OBSTACLE) DEPARTURE PROCEDURES

ORIG 11FEB10 (10042) (FAA)

TAKEOFF MINIMUMS:

Rwys 18L,18R, std. w/ min. climb of 225' per NM to 1100, or 900-2½ for climb in visual conditions.

DEPARTURE PROCEDURE:

Rwys 18L,18R, for climb in visual conditions, cross Southern Illinois airport at or above 1200 MSL before proceeding on course.

TAKEOFF OBSTACLE NOTES:

Rwy 6, road 179' from DER, 214' left of centerline, 418' MSL.

Rwy 18L, tree 3235' from DER, 696' right of centerline, 100' AGL/497' MSL.

Antenna 2731' from DER, 458' left of centerline, 100' AGL/483' MSL.

Tower 2780' from DER, 484' left of centerline, 100' AGL/483' MSL.

Pole 1166' from DER, 192' right of centerline, 100' AGL/439' MSL.

Rwy 24, trees beginning 633' from DER left and right of centerline up to 100' AGL/485' MSL.

Rwy 36L, trees beginning 480' from DER left and right of centerline up to 100' AGL/479' MSL.

CARMI, IL

CARMUNI (CUL)

TAKEOFF MINIMUMS AND (OBSTACLE) DEPARTURE PROCEDURES

AMDT 2 20OCT11 (11293) (FAA)

TAKEOFF OBSTACLE NOTES:

Rwy 18, tree 4288' from DER, 930' right of centerline, 100' AGL/499' MSL.

Rwy 36, tree 3078' from DER, 41' left of centerline, 100' AGL/499' MSL.

CASEY, IL

CASEY MUNI (1H8)

TAKEOFF MINIMUMS AND (OBSTACLE) DEPARTURE PROCEDURES

AMDT 4 29JUL10 (10210) (FAA)

TAKEOFF MINIMUMS:

Rwys 18, 36, NA-Environmental.

TAKEOFF OBSTACLE NOTES:

Rwy 4, tank 4010' from DER, 1464' right of centerline, 140' AGL/785' MSL.

Vehicle on road 651' from DER, 539' right of centerline, 15' AGL/671' MSL.

Trees 998' from DER, 463' right of centerline, 100' AGL/756' MSL.

Rwy 22, vehicle on road 255' from DER, 399' left of centerline, 15' AGL/671' MSL.

Trees 2297' from DER, 766' right of centerline, 100' AGL/756' MSL.

TAKEOFF MINIMUMS, (OBSTACLE) DEPARTURE PROCEDURES, AND DIVERSE VECTOR AREA (RADAR VECTORS)

23278

TAKEOFF MINIMUMS, (OBSTACLE) DEPARTURE PROCEDURES, AND DIVERSE VECTOR AREA (RADAR VECTORS)

23278

CENTRALIA, IL

CENTRALIA MUNI (ENL)

TAKEOFF MINIMUMS AND (OBSTACLE) DEPARTURE PROCEDURES

AMDT 2 31MAY12 (12152) (FAA)

TAKEOFF OBSTACLE NOTES:

Rwy 9, trees beginning 208' from DER, 494' right of centerline, up to 100' AGL/624' MSL.

Trees beginning 528' from DER, 653' left of centerline, up to 100' AGL/624' MSL.

Rwy 18, trees beginning 60' from DER, 265' left of centerline, up to 100' AGL/562' MSL.

Trees beginning 77' from DER, 207' right of centerline, up to 100' AGL/603' MSL.

Silo 1115' from DER, 755' right of centerline, 73' AGL/608' MSL.

Rwy 27, trees beginning 1169' from DER, 493' left of centerline, up to 100' AGL/624' MSL.

Trees beginning 1793' from DER, 377' right of centerline, up to 100' AGL/619' MSL.

Rwy 36, trees and poles beginning 37' from DER, 5' right of centerline, up to 100' AGL/604' MSL.

Trees, poles, and buildings beginning 203' from DER, 363' left of centerline, up to 100' AGL/610' MSL.

CHAMPAIGN/URBANA, IL

UNIVERSITY OF ILLINOIS/WILLARD (CMI)

TAKEOFF MINIMUMS AND (OBSTACLE) DEPARTURE PROCEDURES

AMDT 1 15SEP16 (22027) (FAA)

DEPARTURE PROCEDURE:

Rwy 4, climb heading 044° to 1300 before turning left.

TAKEOFF OBSTACLE NOTES:

Rwy 4, trees beginning 928' from DER, 554' right of centerline, up to 785' MSL.

Trees beginning 1217' from DER, 339' right of centerline, up to 792' MSL.

Tree 1339' from DER, 474' right of centerline, 798' MSL.

Trees beginning 1343' from DER, 166' right of centerline, up to 802' MSL.

Tree 1695' from DER, 535' right of centerline, 803' MSL.

Trees beginning 1699' from DER, 233' right of centerline, up to 804' MSL.

Tree 1728' from DER, 115' left of centerline, 789' MSL.

Tree 2249' from DER, 441' left of centerline, 808' MSL.

Trees beginning 2352' from DER, 411' right of centerline, up to 811' MSL.

Tree 3096' from DER, 121' right of centerline, 826' MSL.

Tree 3502' from DER, 391' right of centerline, 837' MSL.

Tree 3705' from DER, 380' right of centerline, 843' MSL.

Rwy 14R, rod on ol and pole beginning 527' from DER, 388' left of centerline, up to 759' MSL.

Tower and rod on ol gs beginning 543' from DER, 437' left of centerline, up to 37' AGL/780' MSL.

Rwy 32L, tower and asr beginning 1914' from DER, 346' left of centerline, up to 79' AGL/832' MSL.

Rwy 32R, pole and rod on ol pole beginning 844' from DER, 713' right of centerline, up to 33' AGL/783' MSL.

CHETEK, WI

CHETEK MUNI/SOUTHWORTH (Y23)

TAKEOFF MINIMUMS AND (OBSTACLE) DEPARTURE PROCEDURES

ORIG-B 20APR23 (23110) (FAA)

TAKEOFF MINIMUMS:

Rwys 7, 25, NA-Environmental.

TAKEOFF OBSTACLE NOTES:

Rwy 17, trees beginning 44' from DER, 13' left of centerline, up to 100' AGL/1120' MSL.

Vehicle on road 355' from DER, across centerline, 15' AGL/1070' MSL.

Multiple poles beginning 338' from DER, 278' left of centerline, up to 29' AGL/1079' MSL.

AG equipment beginning 27' from DER, 451' right of centerline, 19' AGL/1073' MSL.

Pole 294' from DER, 299' right of centerline, 16' AGL/1070' MSL.

Trees beginning 343' from DER, 7' right of centerline, up to 100' AGL/1137' MSL.

Rwy 35, beacon 79' from DER, 448' left of centerline, 48' AGL/1103' MSL.

Multiple buildings beginning 154' from DER, 339' left of centerline, up to 28' AGL/1082' MSL.

Multiple poles beginning 881' from DER, 135' left of centerline, up to 34' AGL/1088' MSL.

Multiple antennas beginning 1141' from DER, 40' left of centerline, up to 58' AGL/1107' MSL.

Trees beginning 324' from DER, 4' left of centerline, up to 100' AGL/1146' MSL.

Fence 80' from DER, 145' right of centerline, 6' AGL/1061' MSL.

Multiple buildings beginning 144' from DER, 102' right of centerline, up to 22' AGL/1081' MSL.

Multiple poles beginning 452' from DER, 14' right of centerline, up to 75' AGL/1088' MSL.

Trees beginning 64' from DER, 1' right of centerline, up to 100' AGL/1141' MSL.

22 FEB 2024 to 21 MAR 2024

22 FEB 2024 to 21 MAR 2024

TAKEOFF MINIMUMS, (OBSTACLE) DEPARTURE PROCEDURES, AND DIVERSE VECTOR AREA (RADAR VECTORS)

23278

EC-3

TAKEOFF MINIMUMS, (OBSTACLE) DEPARTURE PROCEDURES, AND DIVERSE VECTOR AREA (RADAR VECTORS)

23278

CHICAGO, IL

CHICAGO MIDWAY INTL (MDW)

TAKEOFF MINIMUMS AND (OBSTACLE) DEPARTURE PROCEDURES

AMDT 12A 10SEPT20 (20254) (FAA)

DEPARTURE PROCEDURE:

Rwys 4L/R, climbing right turn to 2400 heading 100° before proceeding on course.

Rwys 13L/C, climb heading 138° to 1500 before turning.

Rwy 13R, climb heading 138° to 1400 before turning.

Rwys 22L/R, climb heading 227° to 1400 before turning.

Rwy 31L, climb heading 318° to 1400 before turning.

Rwys 31C/R, climb heading 318° to 1500 before turning.

TAKEOFF OBSTACLE NOTES:

Rwy 4L, fence 2' from DER, 421' left of centerline, 8' AGL/610' MSL.

Terrain 10' from DER, 492' right of centerline, 606' MSL.

Fence beginning 18' from DER, 256' left of centerline, up to 11' AGL/616' MSL.

Vehicle on road 143' from DER, 161' left of centerline, 620' MSL.

Poles and building beginning 166' from DER, 4' left of centerline, up to 24' AGL/630' MSL.

Poles and tree beginning 374' from DER, 19' right of centerline, up to 28' AGL/633' MSL.

Poles beginning 621' from DER, 27' right of centerline, up to 34' AGL/639' MSL.

Poles beginning 744' from DER, 26' left of centerline, up to 26' AGL/631' MSL.

Poles and trees beginning 1154' from DER, 14' left of centerline, up to 41' AGL/646' MSL.

Tower and pole beginning 1365' from DER, 50' right of centerline, up to 42' AGL/647' MSL.

Sign 1596' from DER, 20' right of centerline, 44' AGL/657' MSL.

Trees and signs beginning 1611' from DER, 33' right of centerline, up to 671' MSL.

Sign and trees beginning 1946' from DER, 19' left of centerline, up to 88' AGL/691' MSL.

Trees and tower beginning 2154' from DER, 145' right of centerline, up to 679' MSL.

Rwy 4R, poles and fence beginning 40' from DER, 21' left of centerline, up to 34' AGL/639' MSL.

Pole 45' from DER, 475' right of centerline, 26' AGL/628' MSL.

Poles, fence and NAVAID beginning 225' from DER, on centerline, up to 29' AGL/634' MSL.

Transmission line, poles and trees beginning 830' from DER, 9' right of centerline, up to 39' AGL/644' MSL.

Pole and transmission line beginning 891' from DER, 43' left of centerline, up to 38' AGL/641' MSL.

Trees, poles, transmission lines and sign beginning 905' from DER, 73' left of centerline, up to 671' MSL.

Tree and tramway beginning 1374' from DER, 570' right of centerline, up to 657' MSL.

Trees beginning 1447' from DER, 369' left of centerline, up to 679' MSL.

Tower 1823' from DER, 110' right of centerline, 61' AGL/672' MSL.

Tower 3983' from DER, 1142' left of centerline, 109' AGL/708' MSL.

Rwy 13C, building 37' from DER, 470' right of centerline, 23' AGL/630' MSL.

Tree, poles, stack, NAVAID, transmission line and building beginning 73' from DER, on centerline, up to 641' MSL.

Building 101' from DER, 253' left of centerline, 15' AGL/625' MSL.

Transmission line and fence beginning 229' from DER, 51' left of centerline, up to 28' AGL/638' MSL.

Tree, poles and building beginning 270' from DER, 143' left of centerline, up to 640' MSL.

Building and poles beginning 391' from DER, 32' left of centerline, up to 32' AGL/641' MSL.

Tree, poles, buildings and sign beginning 503' from DER, 2' left of centerline, up to 647' MSL.

Trees, poles, transmission lines and buildings beginning 613' from DER, 16' right of centerline, up to 660' MSL.

Transmission lines and poles beginning 661' from DER, 12' left of centerline, up to 39' AGL/649' MSL.

Trees, poles, transmission lines and buildings beginning 708' from DER, 12' left of centerline, up to 680' MSL.

Trees beginning 1536' from DER, 79' right of centerline, up to 667' MSL.

Trees beginning 1624' from DER, 116' right of centerline, up to 670' MSL.

Tree 1728' from DER, 937' left of centerline, 684' MSL.

Tree 1793' from DER, 757' right of centerline, 673' MSL.

Tree 1903' from DER, 731' right of centerline, 678' MSL.

Trees beginning 2038' from DER, 568' right of centerline, up to 679' MSL.

Tree 2310' from DER, 869' right of centerline, 684' MSL.

Trees beginning 2368' from DER, 393' right of centerline, up to 689' MSL.

Tree 2799' from DER, 620' right of centerline, 700' MSL.

Rwy 13L, fence 178' from DER, 463' left of centerline, 15' AGL/622' MSL.

Poles beginning 363' from DER, 199' left of centerline, up to 25' AGL/633' MSL.

Poles beginning 488' from DER, 35' left of centerline, up to 27' AGL/634' MSL.

Poles and building beginning 657' from DER, 80' left of centerline, up to 34' AGL/642' MSL.

Pole 701' from DER, 44' right of centerline, 18' AGL/626' MSL.

Pole 812' from DER, 4' right of centerline, 23' AGL/632' MSL.

Transmission lines, buildings and pole beginning 832' from DER, 36' left of centerline, up to 34' AGL/643' MSL.

Poles beginning 897' from DER, 42' right of centerline, up to 23' AGL/633' MSL.

Tree, building and transmission line beginning 945' from DER, 64' left of centerline, up to 645' MSL.

Transmission line and pole beginning 973' from DER, 34' right of centerline, up to 26' AGL/636' MSL.

Transmission lines, building and tree beginning 1043' from DER, 16' right of centerline, up to 34' AGL/644' MSL.

Tree 1170' from DER, 44' left of centerline, 656' MSL.

Trees beginning 1188' from DER, 79' left of centerline, up to 671' MSL.

Trees beginning 1284' from DER, 40' left of centerline, up to 675' MSL.

Tree 1321' from DER, 104' right of centerline, 648' MSL.

Trees, transmission line and pole beginning 1345' from DER, 16' right of centerline, up to 652' MSL.

Trees beginning 1657' from DER, 40' right of centerline, up to 680' MSL.

Tree 2678' from DER, 149' left of centerline, 684' MSL.

CON'T

22 FEB 2024 to 21 MAR 2024

22 FEB 2024 to 21 MAR 2024

TAKEOFF MINIMUMS, (OBSTACLE) DEPARTURE PROCEDURES, AND DIVERSE VECTOR AREA (RADAR VECTORS)

23278

TAKEOFF MINIMUMS, (OBSTACLE) DEPARTURE PROCEDURES, AND DIVERSE VECTOR AREA (RADAR VECTORS)

23278

CHICAGO, IL (CON'T)

CHICAGO MIDWAY INTL (MDW) (CON'T)

Rwy 13R, building 79' from DER, 334' right of centerline, 23' AGL/636' MSL.

Pole 262' from DER, 255' left of centerline, 11' AGL/621' MSL.

Building 458' from DER, 594' right of centerline, 50' AGL/660' MSL.

Building 660' from DER, 291' right of centerline, 49' AGL/661' MSL.

Building 689' from DER, 367' right of centerline, 50' AGL/663' MSL.

Trees, poles and transmission line beginning 977' from DER, 52' right of centerline, up to 692' MSL.

Rwy 22L, poles, building and trees beginning 73' from DER, 1' left of centerline, up to 31' AGL/648' MSL.

Poles beginning 464' from DER, 75' right of centerline, up to 38' AGL/653' MSL.

Trees, transmission lines, buildings and poles beginning 603' from DER, 1' left of centerline, up to 689' MSL.

Trees, poles, buildings and transmission lines beginning 648' from DER, on centerline, up to 675' MSL.

Tree 2094' from DER, 704' right of centerline, 679' MSL.

Tree 2248' from DER, 597' right of centerline, 682' MSL.

Pole 3991' from DER, 1231' left of centerline, 107' AGL/739' MSL.

Tank and water tower beginning 4100' from DER, 160' right of centerline, up to 113' AGL/728' MSL.

Pole 4356' from DER, 846' left of centerline, 107' AGL/740' MSL.

Poles beginning 4484' from DER, 571' left of centerline, up to 107' AGL/743' MSL.

Rwy 22R, fence beginning 7' from DER, 132' right of centerline, up to 12' AGL/630' MSL.

Pole and fence beginning 83' from DER, 63' right of centerline, up to 18' AGL/636' MSL.

Tree, poles, building and fence beginning 142' from DER, 1' right of centerline, up to 647' MSL.

Fence beginning 201' from DER, on centerline, up to 13' AGL/630' MSL.

Poles and fence beginning 281' from DER, 7' left of centerline, up to 18' AGL/635' MSL.

Transmission line and building beginning 330' from DER, 5' right of centerline, up to 34' AGL/650' MSL.

Tree, building, pole and fence beginning 365' from DER, 25' left of centerline, up to 637' MSL.

Transmission lines and buildings beginning 381' from DER, 44' right of centerline, up to 37' AGL/654' MSL.

Tree and pole beginning 471' from DER, 97' left of centerline, up to 640' MSL.

Building 491' from DER, 154' left of centerline, 30' AGL/647' MSL.

Trees, buildings, poles and transmission line beginning 492' from DER, 31' right of centerline, up to 668' MSL.

Transmission line 509' from DER, 28' left of centerline, 35' AGL/650' MSL.

Poles, transmission line and building beginning 574' from DER, 46' left of centerline, up to 37' AGL/653' MSL.

Transmission line 662' from DER, 182' left of centerline, 39' AGL/655' MSL.

Trees and pole beginning 676' from DER, 28' left of centerline, up to 660' MSL.

Trees and buildings beginning 765' from DER, 29' left of centerline, up to 668' MSL.

Tree and building beginning 853' from DER, 47' left of centerline, up to 672' MSL.

Trees and buildings beginning 861' from DER, 30' right of centerline, up to 675' MSL.

Trees, buildings, poles and transmission lines beginning 880' from DER, 18' left of centerline, up to 675' MSL.

Trees and building beginning 1275' from DER, 85' left of centerline, up to 677' MSL.

Trees beginning 1386' from DER, 192' right of centerline, up to 689' MSL.

Tree 2325' from DER, 219' left of centerline, 679' MSL.

Tree 2479' from DER, 326' left of centerline, 682' MSL.

Tank and water tower beginning 4331' from DER, 763' left of centerline, up to 113' AGL/728' MSL.

Rwy 31C, trees and NAVAID beginning 83' from DER, on centerline, up to 648' MSL.

Pole, NAVAID and building beginning 140' from DER, 309' right of centerline, up to 29' AGL/634' MSL.

Transmission line, poles and tree beginning 315' from DER, 20' right of centerline, up to 34' AGL/639' MSL.

Tree 342' from DER, 558' left of centerline, 654' MSL.

Trees, poles, transmission lines and building beginning 395' from DER, 13' left of centerline, up to 658' MSL.

Trees, poles, transmission lines and building beginning 563' from DER, 41' right of centerline, up to 647' MSL.

Transmission lines and poles beginning 1116' from DER, 123' right of centerline, up to 46' AGL/651' MSL.

Trees beginning 1204' from DER, 134' left of centerline, up to 670' MSL.

Tree 1585' from DER, 756' right of centerline, 652' MSL.

Trees beginning 1598' from DER, 654' right of centerline, up to 658' MSL.

Trees beginning 1663' from DER, 14' right of centerline, up to 666' MSL.

Spire 2213' from DER, 709' left of centerline, 77' AGL/682' MSL.

Tree 2374' from DER, 712' right of centerline, 673' MSL.

Tank 5574' from DER, 1451' right of centerline, 162' AGL/756' MSL.

Water tower 5606' from DER, 1420' right of centerline, 160' AGL/757' MSL.

Rwy 31L, terrain 14' from DER, 501' right of centerline, 608' MSL.

Sign 67' from DER, 349' right of centerline, 5' AGL/611' MSL.

Sign 82' from DER, 167' left of centerline, 2' AGL/610' MSL.

Building 338' from DER, 559' left of centerline, 49' AGL/657' MSL.

Building, trees and pole beginning 538' from DER, 57' left of centerline, up to 53' AGL/661' MSL.

Tree 1410' from DER, 51' right of centerline, 648' MSL.

Tree 1716' from DER, 192' left of centerline, 662' MSL.

Tree 1723' from DER, 6' right of centerline, 658' MSL.

Tree 2142' from DER, 689' left of centerline, 674' MSL.

Rwy 31R, transmission line, pole and building beginning 16' from DER, 127' right of centerline, up to 34' AGL/638' MSL.

Trees, buildings, transmission lines and poles beginning 208' from DER, 18' right of centerline, up to 665' MSL.

Pole 256' from DER, 24' left of centerline, 18' AGL/623' MSL.

Trees, poles, transmission line, buildings and sign beginning 345' from DER, 6' left of centerline, up to 640' MSL.

Trees, buildings, NAVAID, transmission lines and poles beginning 574' from DER, 3' left of centerline, up to 655' MSL.

Trees beginning 1792' from DER, 49' right of centerline, up to 667' MSL.

Tree 2030' from DER, 128' left of centerline, 658' MSL.

Tree 2104' from DER, 71' left of centerline, 664' MSL.

22 FEB 2024 to 21 MAR 2024

22 FEB 2024 to 21 MAR 2024

TAKEOFF MINIMUMS, (OBSTACLE) DEPARTURE PROCEDURES, AND DIVERSE VECTOR AREA (RADAR VECTORS)

23278

TAKEOFF MINIMUMS, (OBSTACLE) DEPARTURE PROCEDURES, AND DIVERSE VECTOR AREA (RADAR VECTORS)

23278

CHICAGO, IL (CON'T)

CHICAGO O'HARE INTL (ORD)

TAKEOFF MINIMUMS AND (OBSTACLE) DEPARTURE PROCEDURES

AMDT 23 02DEC21 (21336) (FAA)

TAKEOFF MINIMUMS:

Rwy 22R, NA-ATC.

Rwys 27L/C, std. w/min. climb of 220' per NM to 1800.

Rwy 27R, std. w/min. climb of 220' per NM to 1700.

Rwy 28L, std. w/min. climb of 210' per NM to 900, or alternatively, with standard takeoff minimums and a normal 200' per NM climb gradient, takeoff must occur no later than 1300' prior to DER.

TAKEOFF OBSTACLE NOTES:

Rwy 4L, lighting 6' from DER, 108' right of centerline, 2' AGL/649' MSL.

Pole 587' from DER, 614' right of centerline, 663' MSL.

Building 3275' from DER, 1320' right of centerline, 93' AGL/734' MSL.

Bldg_twr 3301' from DER, 1248' right of centerline, 109' AGL/750' MSL.

Tower, vehicle on road beginning 3341' from DER, 1206' right of centerline, 107' AGL/747' MSL.

Rwy 4R, tree 809' from DER, 610' right of centerline, 675' MSL.

Trees beginning 1108' from DER, 689' right of centerline, up to 700' MSL.

Tree 1306' from DER, 823' right of centerline, 711' MSL.

Antenna 4857' from DER, 1500' right of centerline, 777' MSL.

Rwy 9C, terrain 417' from DER, 586' right of centerline, 666' MSL.

Rwy 9L, building 2771' from DER, 1233' right of centerline, 94' AGL/745' MSL.

Rwy 9R, pole 1026' from DER, 754' right of centerline, 680' MSL.

Pole 1074' from DER, 775' left of centerline, 683' MSL.

Vehicle on road, poles beginning 1076' from DER, 775' left of centerline, up to 41' AGL/684' MSL.

Poles beginning 1171' from DER, 764' right of centerline, up to 682' MSL.

Rwy 10C, tower 1169' from DER, 778' left of centerline, 41' AGL/694' MSL.

Rwy 10L, bldg, sign beginning 2517' from DER, 729' right of centerline, 88' AGL/732' MSL.

Tower 3958' from DER, 1287' right of centerline, 127' AGL/771' MSL.

Pole 4388' from DER, 1585' left of centerline, 124' AGL/762' MSL.

Antenna 4390' from DER, 1585' left of centerline, 125' AGL/763' MSL.

Rwy 10R, tree 2218' from DER, 1016' right of centerline, 714' MSL.

Tree 2248' from DER, 777' right of centerline, 716' MSL.

Tree 2358' from DER, 821' right of centerline, 717' MSL.

Trees beginning 2365' from DER, 732' right of centerline, up to 720' MSL.

Trees beginning 2415' from DER, 690' right of centerline, up to 71' AGL/724' MSL.

Rwy 22L, pole 1301' from DER, 737' right of centerline, 39' AGL/694' MSL.

Rwy 27C, terrain 330' from DER, 577' left of centerline, 684' MSL.

Tree 2426' from DER, 593' left of centerline, 737' MSL.

Tree 2494' from DER, 683' right of centerline, 88' AGL/751' MSL.

Rwy 27L, terrain 486' from DER, 593' right of centerline, 681' MSL.

Terrain 779' from DER, 661' right of centerline, 688' MSL.

Terrain beginning 1177' from DER, 717' left of centerline, up to 707' MSL.

Tree 2426' from DER, 1013' right of centerline, 737' MSL.

Rwy 27R, pole 1051' from DER, 739' left of centerline, 707' MSL.

Vehicle on road 1071' from DER, 560' right of centerline, 698' MSL.

Tree 1248' from DER, 815' right of centerline, 712' MSL.

Tank 1509' from DER, 886' left of centerline, 56' AGL/726' MSL.

Vehicle on road, elevator beginning 2777' from DER, 1019' left of centerline, up to 111' AGL/777' MSL.

Rwy 28C, tree, vehicle on road beginning 2373' from DER, 1099' left of centerline, up to 737' MSL.

Tree 2559' from DER, 257' right of centerline, 737' MSL.

Tree, vehicle on road, 2719' from DER, 1194' left of centerline, up to 80' AGL/750' MSL.

Tree 3526' from DER, 695' left of centerline, 768' MSL.

Vehicle on road 3538' from DER, 702' left of centerline, 97' AGL/771' MSL.

Rwy 28L, vehicle on road beginning 590' from DER, 656' left of centerline, up to 700' MSL.

Vehicle on road, pole beginning 1070' from DER, 697' left of centerline, up to 707' MSL.

Tree 1583' from DER, 803' left of centerline, 724' MSL.

Tree 1608' from DER, 777' left of centerline, 727' MSL.

Trees beginning 1675' from DER, 759' left of centerline, up to 728' MSL.

Trees beginning 1748' from DER, 724' left of centerline, up to 732' MSL.

Trees beginning 1911' from DER, 788' left of centerline, up to 79' AGL/751' MSL.

Tree, vehicles on road beginning 2552' from DER, 717' left of centerline, up to 758' MSL.

Tank 5893' from DER, 740' right of centerline, 167 AGL/834 MSL.

Rwy 28R, tree 2559' from DER, 942' left of centerline, 737' MSL.

22 FEB 2024 to 21 MAR 2024

22 FEB 2024 to 21 MAR 2024

TAKEOFF MINIMUMS, (OBSTACLE) DEPARTURE PROCEDURES, AND DIVERSE VECTOR AREA (RADAR VECTORS)

23278

EC-3

TAKEOFF MINIMUMS, (OBSTACLE) DEPARTURE PROCEDURES, AND

DIVERSE VECTOR AREA (RADAR VECTORS)

23278

CHICAGO, IL (CON'T)**LANSING MUNI (IGQ)****TAKEOFF MINIMUMS AND (OBSTACLE) DEPARTURE PROCEDURES**

AMDT 5 02JUL09 (09183) (FAA)

TAKEOFF MINIMUMS:**Rwy 36**, 300-1¼ or std. w/ min. climb of 322' per NM to 900.**DEPARTURE PROCEDURE:****Rwy 36**, climb heading 002° to 1200 before proceeding on course.**TAKEOFF OBSTACLE NOTES:****Rwy 9**, poles beginning 1203' from DER, from left to right of centerline, up to 32' AGL/647' MSL.

Building 1882' from DER, 964' left of centerline, 50' AGL/668' MSL.

Tower 4314' from DER, 664' left of centerline, 149' AGL/764' MSL.

Rwy 18, trees beginning 381' from DER, 440' right of centerline, up to 42' AGL/661' MSL.**Rwy 27**, hangar and building beginning 254' from DER, 69' right of centerline, up to 26' AGL/641' MSL.

Trees, antennas, antennas on buildings, signs, light poles, and road with vehicles beginning 326' from DER, from left to right of centerline, up to 68' AGL/683' MSL.

Tank 575' from DER, 65' left of centerline, 16' AGL/630' MSL.

Rwy 36, pole 5546' from DER, 1932' right of centerline, 164' AGL/777' MSL.**CHICAGO/AURORA, IL****AURORA MUNI (ARR)****TAKEOFF MINIMUMS AND (OBSTACLE) DEPARTURE PROCEDURES**

AMDT 1 25OCT07 (07298) (FAA)

TAKEOFF OBSTACLE NOTES:**Rwy 9**, vehicle on road 794' from DER, right and left of centerline, 15' AGL/734' MSL.

Multiple trees beginning 4126' from DER, on centerline, 100' AGL/819' MSL.

Rwy 15, multiple trees, power poles and road beginning 900' from DER, 47' right of centerline, up to 100' AGL/809' MSL.

Power pole 1313' from DER, 47' left of centerline, 34' AGL/733' MSL.

Rwy 18, multiple power poles beginning 1218' from DER, 190' right of centerline, up to 35' AGL/734' MSL.

Multiple trees beginning 3646' from DER, on centerline up to 100' AGL/809' MSL.

Rwy 27, vehicle on road 1020' from DER, right and left of centerline, 15' AGL/734' MSL.**Rwy 33**, multiple trees and road beginning 788' from DER, 238' right of centerline, up to 79' AGL/788' MSL.

Road and power pole beginning 577' from DER, 137' left of centerline, up to 38' AGL/747' MSL.

Rwy 36, tree, pole and fence beginning 31' from DER, 169' left of centerline, up to 35' AGL/734' MSL.

Vehicle on road beginning 1099' from DER, right and left of centerline, 15' AGL/734' MSL.

CHICAGO/LAKE IN THE HILLS, IL**LAKE IN THE HILLS (3CK)****TAKEOFF MINIMUMS AND (OBSTACLE) DEPARTURE PROCEDURES**

ORIG-A 05APR12 (12096) (FAA)

TAKEOFF OBSTACLE NOTES:**Rwy 8**, road beginning 118' from DER, left/right and on centerline, 15' AGL/901' MSL.

Multiple trees beginning 2174' from DER, 294' left of centerline, up to 100' AGL/986' MSL.

Multiple trees beginning 3312' from DER, 1023' right of centerline, up to 100' AGL/994' MSL.

Rwy 26, multiple trees beginning 55' from DER, 288' right of centerline, up to 100' AGL/999' MSL.

Multiple trees beginning 299' from DER, 101' left of centerline, up to 100' AGL/959' MSL.

Power lines beginning 1714' from DER, 12' right of centerline, up to 36' AGL/937' MSL.

Power lines beginning 1879' from DER, 87' left of centerline, up to 52' AGL/952' MSL.

22 FEB 2024 to 21 MAR 2024

22 FEB 2024 to 21 MAR 2024

TAKEOFF MINIMUMS, (OBSTACLE) DEPARTURE PROCEDURES, AND

DIVERSE VECTOR AREA (RADAR VECTORS)

23278

TAKEOFF MINIMUMS, (OBSTACLE) DEPARTURE PROCEDURES, AND DIVERSE VECTOR AREA (RADAR VECTORS)

23278

CHICAGO/PROSPECT HEIGHTS/MHEELING, IL

CHICAGO EXEC (PWK)

TAKEOFF MINIMUMS AND (OBSTACLE) DEPARTURE PROCEDURES

AMDT 3A 01FEB18 (21112) (FAA)

TAKEOFF MINIMUMS:

Rwys 6, 24, NA - ATC request.**Rwy 12**, 300-1½ or std. w/ min. climb of 230' per NM to 900, or alternatively, with std. takeoff minimums and a normal 200' per NM climb gradient, takeoff must occur no later than 1700' prior to DER.**Rwy 30**, 300-1 or std. w/ min. climb of 250' per NM to 900, or alternatively, with std. takeoff minimums and a normal 200' per NM climb gradient, takeoff must occur no later than 2000' prior to DER.

TAKEOFF OBSTACLE NOTES:

Rwy 12, building, pole beginning 53' from DER, 57' right of centerline, up to 16' AGL/658' MSL.

Vehicles on traverse way beginning 114' from DER, 484' right of centerline, up to 15' AGL/664' MSL.

Fence, pole beginning 126' from DER, 31' left of centerline, up to 8' AGL/648' MSL.

Building, fence beginning 192' from DER, 133' right of centerline, up to 22' AGL/663' MSL.

Vehicles on traverse way, fence beginning 202' from DER, 7' left of centerline, up to 655' MSL.

Lighting, sign, vehicles on traverse way, building beginning 243' from DER, 51' left of centerline, up to 678' MSL.

Building, tree, vehicles on traverse way, pole beginning 255' from DER, 35' right of centerline, up to 35' AGL/677' MSL.

Tree, vehicles on traverse way, pole beginning 417' from DER, 47' left of centerline, up to 696' MSL.

Tree, pole beginning 561' from DER, 110' left of centerline, up to 699' MSL.

Tree, pole beginning 620' from DER, 6' left of centerline, up to 702' MSL.

Building, pole beginning 661' from DER, 14' right of centerline, up to 32' AGL/681' MSL.

Tree, pole, vehicles on traverse way beginning 712' from DER, 80' right of centerline, up to 684' MSL.

Trees beginning 797' from DER, 139' left of centerline, up to 709' MSL.

Pole, vehicles on traverse way, tree, transmission line beginning 838' from DER, 45' right of centerline, up to 36' AGL/690' MSL.

Tree, vehicles on traverse way beginning 931' from DER, 26' left of centerline, up to 80' AGL/717' MSL.

Tree, pole, transmission line beginning 1186' from DER, 89' right of centerline, up to 703' MSL.

Tree, building, pole beginning 1394' from DER, 112' right of centerline, up to 715' MSL.

Trees beginning 1945' from DER, 44' left of centerline, up to 725' MSL.

Trees beginning 2026' from DER, 20' left of centerline, up to 738' MSL.

Trees beginning 2373' from DER, 66' right of centerline, up to 100' AGL/731' MSL.

Building 4040' from DER, 1148' right of centerline, 114' AGL/755' MSL.

Building 4117' from DER, 1190' right of centerline, 128' AGL/769' MSL.

Pole 1 NM from DER, 2072' left of centerline, 138' AGL/798' MSL.

Building 1.1 NM from DER, 141' left of centerline, 174' AGL/834' MSL.

Building 1.1 NM from DER, 141' left of centerline, 152' AGL/818' MSL.

Rwy 16, general utility 39' from DER, 113' right of centerline, 4' AGL/646' MSL.

Building 55' from DER, 464' right of centerline, 656' MSL.

Building, vehicles on traverse way beginning 91' from DER, 298' right of centerline, up to 658' MSL.

Pole, sign, vehicles on traverse way beginning 275' from DER, 25' right of centerline, up to 29' AGL/672' MSL.

NAVAID 297' from DER, 2' left of centerline, 11' AGL/653' MSL.

Vehicles on traverse way beginning 306' from DER, 365' left of centerline, up to 15' AGL/671' MSL.

Vehicles on traverse way, 319' from DER, 230' left of centerline, 15' AGL/672' MSL.

Vehicles on traverse way beginning 402' from DER, 11' left of centerline, up to 15' AGL/673' MSL.

Tree, transmission line, pole beginning 442' from DER, 62' right of centerline, up to 682' MSL.

Tree, building beginning 573' from DER, 34' left of centerline, up to 38' AGL/680' MSL.

Tree 1026' from DER, 237' right of centerline, 684' MSL.

Tree, pole beginning 1082' from DER, 23' right of centerline, up to 688' MSL.

Tree 1094' from DER, 642' left of centerline, 684' MSL.

Tree, building beginning 1102' from DER, 33' left of centerline, up to 685' MSL.

Trees beginning 1237' from DER, 252' left of centerline, up to 689' MSL.

Trees beginning 1248' from DER, 285' right of centerline, up to 693' MSL.

Tree 1370' from DER, 349' left of centerline, 695' MSL.

Tree, tower beginning 1461' from DER, 183' left of centerline, up to 78' AGL/717' MSL.

Trees beginning 1502' from DER, 14' right of centerline, up to 79' AGL/720' MSL.

Tree 2073' from DER, 894' left of centerline, 718' MSL.

Trees beginning 2173' from DER, 97' right of centerline, up to 726' MSL.

Rwy 30, fence 25' from DER, 108' left of centerline, 5' AGL/650' MSL.

Vehicles on traverse way, fence beginning 47' from DER, 25' right of centerline, up to 658' MSL.

Tree 56' from DER, 285' left of centerline, 36' AGL/683' MSL.

Tree, vehicles on traverse way, fence beginning 77' from DER, 41' left of centerline, up to 689' MSL.

Building, vehicles on traverse way, pole beginning 79' from DER, 66' right of centerline, up to 670' MSL.

Pole, vehicles on traverse way, tree, transmission line beginning 235' from DER, 99' right of centerline, up to 34' AGL/678' MSL.

Building 383' from DER, 594' left of centerline, 44' AGL/691' MSL.

Tree, building beginning 393' from DER, 1' left of centerline, up to 697' MSL.

Tree, building, transmission line, pole beginning 523' from DER, 240' right of centerline, up to 679' MSL.

Tree, building, pole, transmission line beginning 636' from DER, 48' right of centerline, up to 689' MSL.

Tree, building, pole beginning 794' from DER, 123' right of centerline, up to 709' MSL.

Trees beginning 1114' from DER, 82' left of centerline, up to 702' MSL.

Trees beginning 1267' from DER on centerline, up to 89' AGL/730' MSL.

Trees beginning 1580' from DER, 51' left of centerline, up to 712' MSL.

Transmission line 2741' from DER, 1053' left of centerline, 110' AGL/760' MSL.

Transmission line, tree beginning 2977' from DER, 96' left of centerline, up to 118' AGL/768' MSL.

CON'T

TAKEOFF MINIMUMS, (OBSTACLE) DEPARTURE PROCEDURES, AND DIVERSE VECTOR AREA (RADAR VECTORS)

23278

TAKEOFF MINIMUMS, (OBSTACLE) DEPARTURE PROCEDURES, AND DIVERSE VECTOR AREA (RADAR VECTORS)

23278

CHICAGO/PROSPECT HEIGHTS/WHEELING, IL (CON'T)

CHICAGO EXEC (PWK) (CON'T)

Rwy 30 (CON'T), transmission line 3858' from DER, 172' right of centerline, 757' MSL.
Transmission line beginning 3873' from DER, 160' right of centerline, up to 108' AGL/776' MSL.
Transmission line 4732' from DER, 1004' right of centerline, 133' AGL/778' MSL.
Transmission line 4792' from DER, 938' right of centerline, 141' AGL/790' MSL.
Tank, transmission line beginning 5087' from DER, 760' right of centerline, up to 802' MSL.
Rwy 34, sign 26' from DER, 492' right of centerline, 11' AGL/645' MSL.
Sign, general utility beginning 29' from DER, 115' left of centerline, up to 6' AGL/646' MSL.
General utility 39' from DER, 115' right of centerline, 6' AGL/647' MSL.
Tree, pole, vehicles on traverse way beginning 115' from DER, 55' left of centerline, up to 723' MSL.
Vehicles on traverse way 392' from DER, 584' right of centerline, 15' AGL/678' MSL.
Vehicles on traverse way beginning 526' from DER, 331' right of centerline, up to 15' AGL/679' MSL.
Tree, vehicles on traverse way beginning 594' from DER, 29' right of centerline, up to 686' MSL.
Tree, building, pole, transmission line beginning 708' from DER, 225' right of centerline, up to 697' MSL.
Trees beginning 1507' from DER, 491' right of centerline, up to 700' MSL.
Tree, transmission line, pole beginning 1661' from DER, 53' right of centerline, up to 701' MSL.
Trees beginning 2131' from DER, 121' right of centerline, up to 712' MSL.
Tree 2862' from DER, 637' right of centerline, 716' MSL.
Tree 2927' from DER, 106' right of centerline, 723' MSL.
Trees beginning 2986' from DER, 373' right of centerline, up to 727' MSL.

CHICAGO/ROCKFORD, IL

CHICAGO/ROCKFORD INTL (RFD)

TAKEOFF MINIMUMS AND (OBSTACLE) DEPARTURE PROCEDURES

AMDT 1 11AUG22 (22223) (FAA)

TAKEOFF MINIMUMS:

Rwy 7, 300-1¼ or std. w/min. climb of 230' per NM to 1000, or alternatively, with std. takeoff minimums and a normal 200' per NM climb gradient, takeoff must occur no later than 1700' prior to DER.

TAKEOFF OBSTACLE NOTES:

Rwy 1, tree 1287' from DER, 674' left of centerline, 772' MSL.
Tree 1481' from DER, 895' left of centerline, 779' MSL.
Trees, transmission line, pole beginning 1522' from DER, 658' left of centerline, up to 784' MSL.
Tree 1692' from DER, 893' left of centerline, 787' MSL.
Tree 1967' from DER, 843' left of centerline, 794' MSL.
Rwy 7, general utility 38' from DER, 146' right of centerline, 6' AGL/739' MSL.
General utility 38' from DER, 150' left of centerline, 3' AGL/737' MSL.
Pole 544' from DER, 596' right of centerline, 771' MSL.
Transmission line, poles, buildings, traverse way beginning 554' from DER, 274' right of centerline, up to 36' AGL/773' MSL.
Transmission line, pole beginning 958' from DER, 660' right of centerline, up to 40' AGL/775' MSL.
Trees beginning 1021' from DER, 591' right of centerline, up to 787' MSL.
Trees beginning 1110' from DER, 472' right of centerline, up to 61' AGL/794' MSL.
Trees beginning 1204' from DER, 157' right of centerline, up to 802' MSL.
Trees beginning 1529' from DER, 353' left of centerline, up to 779' MSL.
Trees beginning 1604' from DER, 255' left of centerline, up to 790' MSL.
Tree 2439' from DER, 1082' right of centerline, 805' MSL.
Tower 5359' from DER, 1786' left of centerline, 140' AGL/888' MSL.
Rwy 19, vertical point 1' from DER, 4' left of centerline, 1' AGL/710' MSL.
Vertical point, sign beginning 3' from DER, 300' right of centerline, up to 1' AGL/711' MSL.
Tree 861' from DER, 699' right of centerline, 752' MSL.
Trees beginning 1413' from DER, 793' left of centerline, up to 769' MSL.
Tree 1720' from DER, 913' right of centerline, 758' MSL.
Trees beginning 2083' from DER, 792' right of centerline, up to 786' MSL.
Trees beginning 2221' from DER, 989' right of centerline, up to 794' MSL.
Rwy 25, NAVAJD 7' from DER, 4' left of centerline, 1' AGL/743' MSL.
Trees beginning 4102' from DER, 1082' left of centerline, up to 123' AGL/860' MSL.
Tree 4558' from DER, 1316' left of centerline, 84' AGL/861' MSL.
Trees beginning 4660' from DER, 947' left of centerline, up to 866' MSL.
Tree 4964' from DER, 1175' left of centerline, 76' AGL/870' MSL.

CHICAGO/ROMEOVILLE, IL

LEWIS UNIVERSITY (LOT)

TAKEOFF MINIMUMS AND (OBSTACLE) DEPARTURE PROCEDURES

AMDT 1 03JUN10 (10154) (FAA)

TAKEOFF MINIMUMS:

Rwy 2, 300-1¼ or std. w/ min. climb of 420' per NM to 1200.

DEPARTURE PROCEDURE:

Rwy 2, climb heading 016° to 1300 before turning right.

TAKEOFF OBSTACLE NOTES:

Rwy 2, multiple towers, tree, and stack beginning 1196' from DER, 49' left of centerline, up to 213' AGL/876' MSL.
Rwy 9, multiple trees and building beginning 243' from DER, 358' left of centerline, up to 64' AGL/735' MSL.
Multiple light poles, trees, and sign beginning 112' from DER, 174' right of centerline, up to 77' AGL/721' MSL.
Rwy 27, multiple trees beginning 1143' from DER, 634' right of centerline, up to 70' AGL/723' MSL.

TAKEOFF MINIMUMS, (OBSTACLE) DEPARTURE PROCEDURES, AND DIVERSE VECTOR AREA (RADAR VECTORS)

23278

TAKEOFF MINIMUMS, (OBSTACLE) DEPARTURE PROCEDURES, AND DIVERSE VECTOR AREA (RADAR VECTORS)

23278

CHICAGO/WAUKEGAN, IL

WAUKEGAN NTL (UGN)

TAKEOFF MINIMUMS AND (OBSTACLE) DEPARTURE PROCEDURES

AMDT 1A 07DEC17 (21112) (FAA)

TAKEOFF OBSTACLE NOTES:

Rwy 5, trees beginning 328' from DER, 493' left of centerline, up to 58' AGL/759' MSL.

Rwy 14, hangar 196' from DER, 453' left of centerline, 30' AGL/749' MSL.

Bush 362' from DER, 130' left of centerline, 17' AGL/728' MSL.

Bush 371' from DER, 161' right of centerline, 14' AGL/725' MSL.

Hangar 920' from DER, 452' right of centerline, 30' AGL/749' MSL.

Rwy 23, trees beginning 89' from DER, 344' right of centerline, up to 59' AGL/780' MSL.

Trees beginning 212' from DER, 372' left of centerline, up to 44' AGL/758' MSL.

Trees beginning 925' from DER, left and right of centerline, up to 73' AGL/797' MSL.

Rwy 32, terrain beginning 7' from DER, 112' left of centerline, up to 738' MSL.

Terrain 122' from DER, 249' right of centerline, 734' MSL.

Vehicle on road 232' from DER, 124' right of centerline, up to 15' AGL/752' MSL.

Trees, bush and wind vane on building beginning 246' from DER, left and right of centerline, up to 54' AGL/784' MSL.

Trees 1560' from DER, 259' right of centerline, 70' AGL/801' MSL.

CHICAGO/WEST CHICAGO, IL

DUPAGE (DPA)

TAKEOFF MINIMUMS AND (OBSTACLE) DEPARTURE PROCEDURES

AMDT 1B 08NOV18 (18312) (FAA)

TAKEOFF MINIMUMS:

Rwy 15, 300-1% or std. w/min. climb of 205' per NM to 1000.

TAKEOFF OBSTACLE NOTES:

Rwy 2L, electrical system 9' from DER, 60' left of centerline, 5' AGL/756' MSL.

Transmission line, pole beginning 1075' from DER, 621' left of centerline, up to 39' AGL/792' MSL.

Fence, transmission line beginning 1431' from DER, 745' left of centerline, up to 44' AGL/799' MSL.

Tree, fence beginning 1635' from DER, 635' left of centerline, up to 807' MSL.

Trees beginning 2248' from DER, 447' left of centerline, up to 831' MSL.

Tree 2795' from DER, 930' left of centerline, 835' MSL.

Trees beginning 2832' from DER, 368' left of centerline, up to 836' MSL.

Trees beginning 2868' from DER, 407' left of centerline, up to 841' MSL.

Tree 3866' from DER, 790' left of centerline, 104' AGL/856' MSL.

Rwy 2R, lighting 2' from DER, 30' left of centerline, 1' AGL/759' MSL.

Rwy 10, lighting, NAVAJD beginning 39' from DER, 77' right of centerline, up to 757' MSL.

Building 629' from DER, 611' left of centerline, 22' AGL/777' MSL.

Tower 699' from DER, 632' left of centerline, 36' AGL/792' MSL.

Tree 845' from DER, 679' left of centerline, 805' MSL.

Tree, pole, tower beginning 871' from DER, 1' left of centerline, up to 815' MSL.

Tree, building, pole, stack beginning 1435' from DER, 133' right of centerline, up to 827' MSL.

Trees beginning 1944' from DER, 130' right of centerline, up to 829' MSL.

Trees beginning 2369' from DER, 170' left of centerline, up to 839' MSL.

Tree 3006' from DER, 502' right of centerline, 841' MSL.

Trees beginning 3396' from DER, 885' right of centerline, up to 849' MSL.

Rwy 15, tree, fence, vehicles on traverse way beginning 3' from DER, 240' left of centerline, up to 796' MSL.

Tree, vehicles on traverse way, building beginning 136' from DER, 9' left of centerline, up to 44' AGL/797' MSL.

Tree 493' from DER, 458' left of centerline, 809' MSL.

Tree 538' from DER, 564' left of centerline, 813' MSL.

Tree, vehicles on traverse way beginning 564' from DER, 74' right of centerline, up to 74' AGL/836' MSL.

Tree, vehicles on traverse way, building, pole, transmission line beginning 697' from DER, 8' right of centerline, up to 838' MSL.

Trees beginning 1578' from DER, 29' left of centerline, up to 95' AGL/850' MSL.

Tower 1 NM from DER, 1677' left of centerline, 165' AGL/927' MSL.

Rwy 20L, sign beginning 19' from DER, 89' right of centerline, up to 3' AGL/752' MSL.

Fence 209' from DER, 547' left of centerline, 10' AGL/757' MSL.

Tree 614' from DER, 481' left of centerline, 773' MSL.

Trees beginning 1058' from DER, 725' left of centerline, up to 805' MSL.

Tree 1204' from DER, 736' left of centerline, 806' MSL.

Tree 1455' from DER, 812' left of centerline, 816' MSL.

Trees beginning 1482' from DER, 398' left of centerline, up to 820' MSL.

Trees beginning 2194' from DER, 967' left of centerline, up to 844' MSL.

Trees beginning 2346' from DER, 888' left of centerline, up to 102' AGL/849' MSL.

Rwy 20R, vertical structure 19' from DER, 88' left of centerline, 3' AGL/753' MSL.

Tree 645' from DER, 616' right of centerline, 768' MSL.

Rwy 28, sign 38' from DER, 454' right of centerline, 3' AGL/756' MSL.

Building 974' from DER, 681' right of centerline, 781' MSL.

Tree 1227' from DER, 683' right of centerline, 789' MSL.

Tree 1951' from DER, 968' left of centerline, 810' MSL.

Tree 2146' from DER, 971' left of centerline, 814' MSL.

Trees beginning 2603' from DER, 1025' left of centerline, up to 830' MSL.

Tree 2874' from DER, 1073' right of centerline, 837' MSL.

CONT

22 FEB 2024 to 21 MAR 2024

22 FEB 2024 to 21 MAR 2024

TAKEOFF MINIMUMS, (OBSTACLE) DEPARTURE PROCEDURES, AND DIVERSE VECTOR AREA (RADAR VECTORS)

23278

EC-3

TAKEOFF MINIMUMS, (OBSTACLE) DEPARTURE PROCEDURES, AND DIVERSE VECTOR AREA (RADAR VECTORS)

23278

CHICAGO/WEST CHICAGO, IL (CON'T)

DUPAGE (DPA) (CON'T)

Rwy 33, terrain 15' from DER, 436' left of centerline, 759' MSL.
 NAVAID, terrain beginning 50' from DER, 94' right of centerline, up to 760' MSL.
 Building 195' from DER, 451' right of centerline, 24' AGL/778' MSL.
 Building 239' from DER, 424' right of centerline, 25' AGL/780' MSL.
 Tree, fence beginning 335' from DER, 338' left of centerline, up to 807' MSL.
 Tree, pole, vehicles on traverse way, building beginning 354' from DER, 154' right of centerline, up to 810' MSL.
 Tree, pole beginning 653' from DER, 168' right of centerline, up to 812' MSL.
 Tree, pole beginning 704' from DER, 340' right of centerline, up to 817' MSL.
 Tree, pole, transmission line beginning 713' from DER, 6' left of centerline, up to 826' MSL.
 Tree, pole beginning 835' from DER, 29' right of centerline, up to 832' MSL.
 Tree, pole beginning 904' from DER, 76' right of centerline, up to 836' MSL.
 Trees beginning 1068' from DER, 521' left of centerline, up to 838' MSL.
 Tree, pole, transmission line beginning 1106' from DER, 153' right of centerline, up to 841' MSL.
 Trees beginning 1687' from DER, 20' left of centerline, up to 844' MSL.
 Trees beginning 1865' from DER, 11' right of centerline, up to 847' MSL.
 Trees beginning 2250' from DER, 247' left of centerline, up to 96' AGL/854' MSL.
 Trees beginning 2450' from DER, 32' right of centerline, up to 110' AGL/859' MSL.

CLINTONVILLE, WI

CLINTONVILLE MUNI (CLI)

TAKEOFF MINIMUMS AND (OBSTACLE) DEPARTURE PROCEDURES

AMDT 2A 24MAY18 (18144) (FAA)

TAKEOFF MINIMUMS:

Rwys 9, 27, 22, NA-environmental.

TAKEOFF OBSTACLE NOTES:

Rwy 4, trees beginning 79' from DER, 252' left of centerline, up to 822' MSL.
 Tree and ground beginning 172' from DER, 277' right of centerline, up to 856' MSL.
 Trees beginning 192' from DER, 202' left of centerline, up to 832' MSL.
 Tree 352' from DER, 521' left of centerline, 836' MSL.
 Tree 376' from DER, 563' right of centerline, 877' MSL.
 Tree 392' from DER, 466' right of centerline, 901' MSL.
 Trees beginning 397' from DER, 322' left of centerline, up to 864' MSL.
 Tree, grain bin/silo, and elevator beginning 508' from DER, 440' right of centerline, up to 905' MSL.
Rwy 14, tree 22' from DER, 488' right of centerline, 829' MSL.
 Trees beginning 39' from DER, 118' left of centerline, up to 829' MSL.
 Trees beginning 94' from DER, 248' right of centerline, up to 847' MSL.
 Trees beginning 202' from DER, 402' left of centerline, up to 836' MSL.
 Tree 305' from DER, 464' left of centerline, 838' MSL.
 Tree 371' from DER, 274' right of centerline, 849' MSL.
 Trees beginning 388' from DER, 341' right of centerline, up to 850' MSL.
 Tree 517' from DER, 484' left of centerline, 846' MSL.
 Trees beginning 524' from DER, 63' right of centerline, up to 854' MSL.
 Trees beginning 525' from DER, 145' left of centerline, up to 863' MSL.
 Trees beginning 691' from DER, 144' right of centerline, up to 870' MSL.
 Trees beginning 1253' from DER, 685' right of centerline, up to 882' MSL.
 Trees beginning 1362' from DER, 266' right of centerline, up to 885' MSL.
 Trees beginning 1416' from DER, 246' right of centerline, up to 893' MSL.
 Tree 1995' from DER, 709' left of centerline, 872' MSL.
 Trees beginning 2086' from DER, 735' left of centerline, up to 877' MSL.
 Tree 2233' from DER, 1044' left of centerline, 882' MSL.
 Tree 2336' from DER, 660' left of centerline, 884' MSL.
 Trees beginning 2417' from DER, 596' left of centerline, up to 891' MSL.
 Tree 3179' from DER, 194' right of centerline, 896' MSL.
Rwy 32, ground 32' from DER, 449' left of centerline, 824' MSL.
 Ground 160' from DER, 373' left of centerline, 825' MSL.
 Pole 199' from DER, 454' left of centerline, 6' AGL/833' MSL.
 Pole and ground beginning 286' from DER, 365' left of centerline, up to 8' AGL/834' MSL.
 Pole 421' from DER, 572' left of centerline, 8' AGL/839' MSL.
 Trees beginning 759' from DER, 410' left of centerline, up to 882' MSL.
 Tree and pole beginning 958' from DER, 447' left of centerline, up to 886' MSL.
 Trees beginning 1098' from DER, 76' right of centerline, up to 880' MSL.
 Trees beginning 1105' from DER, 532' left of centerline, up to 891' MSL.
 Tree 1231' from DER, 656' left of centerline, 896' MSL.
 Trees beginning 1254' from DER, 51' left of centerline, up to 900' MSL.
 Trees beginning 1511' from DER, 189' right of centerline, up to 887' MSL.
 Trees beginning 1600' from DER, 301' right of centerline, up to 894' MSL.
 Trees beginning 1633' from DER, 4' right of centerline, up to 897' MSL.
 Trees beginning 2670' from DER, 321' left of centerline, up to 901' MSL.
 Tree 3270' from DER, 199' right of centerline, 906' MSL.
 Tree 3318' from DER, 280' right of centerline, 908' MSL.

22 FEB 2024 to 21 MAR 2024

22 FEB 2024 to 21 MAR 2024

TAKEOFF MINIMUMS, (OBSTACLE) DEPARTURE PROCEDURES, AND DIVERSE VECTOR AREA (RADAR VECTORS)

23278

EC-3

TAKEOFF MINIMUMS, (OBSTACLE) DEPARTURE PROCEDURES, AND DIVERSE VECTOR AREA (RADAR VECTORS)

23278

CRANDON, WI

CRANDON/STEVE CONWAY MUNI (Y55)

TAKEOFF MINIMUMS AND (OBSTACLE) DEPARTURE PROCEDURES

ORIG 08JAN15 (15008) (FAA)

TAKEOFF MINIMUMS:

Rwys 1, 19, NA – Environmental.

Rwy 30, 300-2 or std. w/min. climb of 218' per NM to 2100, or alternatively with std. takeoff minimums and a normal 200' per NM climb gradient, takeoff must occur no later than 1800' prior to DER.

TAKEOFF OBSTACLE NOTES:

Rwy 12, tree 21' from DER, 315' left of centerline, 3' AGL/1630' MSL.

Obstruction light wind sock 89' from DER, 222' left of centerline, 20' AGL/1649' MSL.

Vehicle on roadway 302' from DER, 258' left to right of centerline, 15' AGL/1644' MSL.

Buildings 438' from DER, 386' right of centerline, up to 19' AGL/1648' MSL.

Apbn 474' from DER, 492' right of centerline, 39' AGL/1668' MSL.

Tree 475' from DER, 437' left of centerline, 17' AGL/1646' MSL.

Pole 678' from DER, 629' right of centerline, 21' AGL/1650' MSL.

Trees beginning from 831' from DER, 222' right of centerline, up to 66' AGL/1685' MSL.

Rwy 30, trees beginning 3' from DER, 199' right of centerline, up to 10' AGL/1659' MSL.

Trees beginning 105' from DER, 236' right of centerline, up to 11' AGL/1661' MSL.

Trees beginning 1096' from DER, 42' left of centerline, up to 50' AGL/1679' MSL.

Trees beginning 1126' from DER, 181' left to right of centerline, up to 78' AGL/1707' MSL.

Trees beginning 3974' from DER, 166' right of centerline, up to 86' AGL/1795' MSL.

Trees beginning 5974' from DER, 1892' right of centerline, up to 100' AGL/1939' MSL.

CUMBERLAND WI

CUMBERLAND MUNI (UBE)

TAKEOFF MINIMUMS AND (OBSTACLE) DEPARTURE PROCEDURES

ORIG 31MAR16 (16091) (FAA)

TAKEOFF MINIMUMS:

Rwy 18, 36, NA-Environmental.

TAKEOFF OBSTACLE NOTES:

REIL 9, REIL 35' from DER, 107' right of centerline, 3' AGL/1235' MSL.

REIL 35' from DER, 107' left of centerline, 4' AGL/1235' MSL.

Pole 662' from DER, 456' left of centerline, 29' AGL/1260' MSL.

Trees beginning 802' from DER, 573' left of centerline, up to 1292' MSL.

Tree 1618' from DER, 269' right of centerline, 1283' MSL.

Trees beginning 1946' from DER, 64' right of centerline, up to 1298' MSL.

Trees beginning 1947' from DER, 66' left of centerline, up to 1294' MSL.

Trees beginning 1954' from DER, 288' left of centerline, up to 1296' MSL.

Tree 2312' from DER, 1100' left of centerline, 1307' MSL.

Rwy 27, pole 10' from DER, 15' right of centerline, 2' AGL/1244' MSL.

Fence 54' from DER, 386' right of centerline, 4' AGL/1246' MSL.

Vehicles on road beginning 634' from DER, left and right of centerline, up to 15' AGL/1262' MSL.

Building 852' from DER, 425' left of centerline, 29' AGL/1271' MSL.

Tree 3356' from DER, 394' right of centerline, 1330' MSL.

DANVILLE, IL

VERMILION RGNL (DNV)

TAKEOFF MINIMUMS AND (OBSTACLE) DEPARTURE PROCEDURES

ORIG 02JUL09 (09183) (FAA)

TAKEOFF OBSTACLE NOTES:

Rwy 3, tree 2298' from DER, 725' right of centerline, 50' AGL/761' MSL.

Rwy 16, tree 4101' from DER, 378' left of centerline, 50' AGL/789' MSL.

Rwy 21, tree 1982' from DER, 802' left of centerline, 50' AGL/728' MSL.

Rwy 34, tree 3460' from DER, 2' right of centerline, 50' AGL/812' MSL.

DE KALB, IL

DE KALB TAYLOR MUNI (DKB)

TAKEOFF MINIMUMS AND (OBSTACLE) DEPARTURE PROCEDURES

AMDT 4A 30APR15 (15120) (FAA)

TAKEOFF MINIMUMS:

Rwy 27, 300-1.

DEPARTURE PROCEDURE:

Rwy 9, climb runway heading to 1400 before proceeding on course.

TAKEOFF OBSTACLE NOTES:

Rwy 9, antenna tower 4363' from DER, 760' right of centerline, 130' AGL/1024' MSL.

TAKEOFF MINIMUMS, (OBSTACLE) DEPARTURE PROCEDURES, AND DIVERSE VECTOR AREA (RADAR VECTORS)

23278

EC-3

TAKEOFF MINIMUMS, (OBSTACLE) DEPARTURE PROCEDURES, AND DIVERSE VECTOR AREA (RADAR VECTORS)

23278

DECATUR, IL

DECATUR (DEC)

TAKEOFF MINIMUMS AND (OBSTACLE) DEPARTURE PROCEDURES

AMDT 3 23SEP10 (10266) (FAA)

DEPARTURE PROCEDURE:

Rwy 6, climb heading 060° to 1700 before turning left.

Rwy 30, climb heading 300° to 1400 before turning right.

Rwy 36, climbing left turn to intercept AXC VORTAC R-340 to 2000 before proceeding on course.

TAKEOFF OBSTACLE NOTES:

Rwy 24, pole 802' from DER, 664' left of centerline, 30' AGL/704' MSL.

Trees beginning 895' from DER, 722' right of centerline, up to 88' AGL/762' MSL.

Rwy 30, trees beginning 948' from DER, 395' left of centerline, up to 78' AGL/742' MSL.

Trees beginning 1314' from DER, 57' right of centerline, up to 90' AGL/739' MSL.

Rwy 36, trees beginning 1549' from DER, 14' left of centerline, up to 75' AGL/749' MSL.

Trees beginning 460' from DER, 84' right of centerline, up to 72' AGL/751' MSL.

DIXON, IL

DIXON MUNI-CHARLES R WALGREEN FLD (C73)

TAKEOFF MINIMUMS AND (OBSTACLE) DEPARTURE PROCEDURES

AMDT 4 10JAN13 (21224) (FAA)

TAKEOFF MINIMUMS:

Rwy 26, 400-2½ or std. w/min. climb of 250' per NM to 1300.

TAKEOFF OBSTACLE NOTES:

Rwy 8, vehicle on road beginning 336' from DER, on centerline, up to 15' AGL/798' MSL.

Rwy 12, railroad track beginning 198' from DER, 288' right of centerline, up to 23' AGL/810' MSL.

Vehicle on road beginning 150' from DER, 106' left of centerline, up to 15' AGL/794' MSL.

Monopole 1606' from DER, 411' left of centerline, 45' AGL/827' MSL.

Rwy 26, tower 2.0 NM from DER, 707' left of centerline, 749' AGL/1100' MSL.

Light poles beginning 166' from DER, 361' right of centerline, up to 39' AGL/806' MSL.

Stack 793' from DER, 672' right of centerline, 60' AGL/843' MSL.

Railroad tracks 572' from DER, 305' right of centerline, 23' AGL/803' MSL.

Rooftops beginning 428' from DER, 413' right of centerline, up to 36' AGL/805' MSL.

Trees beginning 330' from DER, 83' left and right of centerline, up to 14' AGL/833' MSL.

Rwy 30, rooftops beginning 321' from DER, 140' left of centerline, up to 62' AGL/833' MSL.

Power line beginning 259' from DER, 120' right of centerline, up to 100' AGL/870' MSL.

Trees beginning 769' from DER, 211' left and right of centerline, up to 100' AGL/896' MSL.

EAGLE RIVER, WI

EAGLE RIVER UNION (EGV)

TAKEOFF MINIMUMS AND (OBSTACLE) DEPARTURE PROCEDURES

ORIG-A 05NOV20 (20310) (FAA)

TAKEOFF OBSTACLE NOTES:

Rwy 4, vehicle on road 240' from DER, 559' right of centerline, 15' AGL/1654' MSL, terrain 51' from DER, 288' right of centerline, 1639' MSL.

Rwy 13, vehicle on road 268' from DER, 572' left of centerline, 15' AGL/1654' MSL, antenna tower, 1816' from DER, 487' left of centerline, 60' AGL/1708' MSL.

Rwy 22, vehicle on road 246' from DER, 566' right of centerline, 15' AGL/1654' MSL, multiple trees 476' from DER, 430' right of centerline, 83' AGL/1722' MSL, multiple trees 761' from DER, 147' left of centerline, 96' AGL/1735' MSL.

EAST TROY, WI

EAST TROY MUNI (57C)

TAKEOFF MINIMUMS AND (OBSTACLE) DEPARTURE PROCEDURES

ORIG 29JUL10 (10210) (FAA)

TAKEOFF MINIMUMS:

Rwys 18, 36, NA-Environmental.

TAKEOFF OBSTACLE NOTES:

Rwy 8, trees beginning 106' from DER, 45' right of centerline, up to 100' AGL/979' MSL.

Trees beginning 34' from DER, 6' left of centerline, up to 100' AGL/908' MSL.

Rwy 26, vehicle on road 346' from DER, 17' right of centerline, up to 15' AGL/865' MSL.

Vehicle on road 561' from DER, 588' left of centerline, up to 15' AGL/865' MSL.

Vehicle on road 607' from DER, 46' right of centerline, up to 17' AGL/867' MSL.

Trees beginning 1850' from DER, 131' right of centerline, up to 100' AGL/989' MSL.

Trees beginning 2870' from DER, 431' left of centerline, up to 100' AGL/959' MSL.

TAKEOFF MINIMUMS, (OBSTACLE) DEPARTURE PROCEDURES, AND DIVERSE VECTOR AREA (RADAR VECTORS)

23278

EC-3

TAKEOFF MINIMUMS, (OBSTACLE) DEPARTURE PROCEDURES, AND DIVERSE VECTOR AREA (RADAR VECTORS)

23278

EAU CLAIRE, WI

CHIPPEWA VALLEY RGNL (EAU)

TAKEOFF MINIMUMS AND (OBSTACLE) DEPARTURE PROCEDURES

AMDT 2A 01FEB18 (18032) (FAA)

TAKEOFF MINIMUMS:

Rwy 14, 500-2¼ or standard w/ min. climb of 307' per NM to 1500.

Rwy 32, 200-1½ or standard w/ min. climb of 302' per NM to 1200.

DEPARTURE PROCEDURE:

Rwy 14, climb heading 138° to 2000 before proceeding on course.

Rwy 22, climb heading 224° to 1700 before proceeding on course.

Rwy 32, climb heading 304° to 1700 before proceeding on course.

TAKEOFF OBSTACLE NOTES:

Rwy 14, pole, fence beginning 57' from DER, 302' right of centerline, up to 25' AGL/910' MSL.

Tree, pole beginning 146' from DER, 359' right of centerline, up to 925' MSL.

Trees beginning 817' from DER, 449' right of centerline, up to 949' MSL.

Pole 897' from DER, 619' left of centerline, 34' AGL/935' MSL.

Tree, pole beginning 927' from DER, 339' right of centerline, up to 954' MSL.

Tree 998' from DER, 593' left of centerline, 944' MSL.

Trees beginning 1041' from DER, 27' left of centerline, up to 951' MSL.

Trees beginning 1205' from DER, 5' right of centerline, up to 955' MSL.

Tree, stack beginning 1465' from DER, 50' left of centerline, up to 959' MSL.

Tree 2487' from DER, 545' right of centerline, 962' MSL.

Trees beginning 4159' from DER, 971' right of centerline, up to 997' MSL.

tree 1 NM from DER, 1489' left of centerline, 1057' MSL.

Tree 1 NM from DER, 511' left of centerline, 1060' MSL.

Tree 1 NM from DER, 1116' left of centerline, 1063' MSL.

Trees beginning 1 NM from DER, 826' left of centerline, up to 1076' MSL.

Trees beginning 1 NM from DER, 616' left of centerline, up to 1080' MSL.

Trees beginning 1 NM from DER, 360' left of centerline, up to 1083' MSL.

Trees beginning 1.1 NM from DER, 1114' left of centerline, up to 1097' MSL.

Trees beginning 1.1 NM from DER, 755' left of centerline, up to 1110' MSL.

Trees beginning 1.1 NM from DER, 612' left of centerline, up to 1116' MSL.

Trees beginning 1.1 NM from DER, 354' left of centerline, up to 1117' MSL.

Trees beginning 1.1 NM from DER, 924' left of centerline, up to 1122' MSL.

Trees beginning 1.1 NM from DER, 214' left of centerline, up to 1140' MSL.

Tree 1.1 NM from DER, 625' left of centerline, 1148' MSL.

Trees beginning 1.1 NM from DER, 128' left of centerline, up to 1150' MSL.

Trees beginning 1.1 NM from DER, 157' left of centerline, up to 1154' MSL.

Trees beginning 1.1 NM from DER, 364' left of centerline, up to 1158' MSL.

Trees beginning 1.1 NM from DER, 20' right of centerline, up to 1090' MSL.

Trees beginning 1.1 NM from DER, 159' right of centerline, up to 1095' MSL.

Tree, pole beginning 1.1 NM from DER, 47' right of centerline, up to 1112' MSL.

Trees beginning 1.1 NM from DER, 25' left of centerline, up to 1164' MSL.

Trees beginning 1.2 NM from DER, 203' right of centerline, up to 1113' MSL.

Transmission line beginning 1.2 NM from DER, 547' right of centerline, up to 64' AGL/1114' MSL.

Tree, transmission line, pole beginning 1.2 NM from DER, 79' right of centerline, up to 1119' MSL.

Tree, transmission line beginning 1.2 NM from DER, 47' left of centerline, up to 1169' MSL.

Trees beginning 1.3 NM from DER, 1603' right of centerline, up to 1120' MSL.

Towers beginning 2.2 NM from DER, 4' left of centerline, up to 455' AGL/1349' MSL.

Rwy 32, traverse-way 10' from DER, 443' left of centerline, 893' MSL.

Traverse-way 116' from DER, 438' left of centerline, 15' AGL/895' MSL.

Tree, traverse-way beginning 184' from DER, 416' left of centerline, up to 928' MSL.

Trees beginning 482' from DER, 391' left of centerline, up to 931' MSL.

Trees beginning 561' from DER, 565' right of centerline, up to 927' MSL.

Trees beginning 903' from DER, 371' right of centerline, up to 939' MSL.

Tree 1054' from DER, 702' right of centerline, 942' MSL.

Tree, building beginning 1059' from DER, 388' right of centerline, up to 943' MSL.

Trees beginning 1299' from DER, 520' right of centerline, up to 948' MSL.

Tree 4343' from DER, 967' left of centerline, 994' MSL.

Tree 4367' from DER, 1423' left of centerline, 1001' MSL.

Tree 4385' from DER, 1581' left of centerline, 1008' MSL.

Trees beginning 4448' from DER, 1167' left of centerline, up to 1017' MSL.

Tree 4470' from DER, 1412' left of centerline, 1023' MSL.

Trees beginning 4554' from DER, 1209' left of centerline, up to 1025' MSL.

Tree 4563' from DER, 1355' left of centerline, 1029' MSL.

Trees beginning 4572' from DER, 1230' left of centerline, up to 1037' MSL.

Tree 4674' from DER, 1602' left of centerline, 1040' MSL.

Trees beginning 4685' from DER, 1132' left of centerline, up to 1048' MSL.

Trees beginning 4809' from DER, 1089' left of centerline, up to 1059' MSL.

Trees beginning 4917' from DER, 1038' left of centerline, up to 81' AGL/1067' MSL.

Trees beginning 5004' from DER, 756' left of centerline, up to 78' AGL/1070' MSL.

Trees beginning 5051' from DER, 442' left of centerline, up to 73' AGL/1073' MSL.

Tree, transmission line beginning 5370' from DER, 95' left of centerline, up to 1077' MSL.

Tree 1.1 NM from DER, 1985' left of centerline, 85' AGL/1078' MSL.

Tree 1.1 NM from DER, 2361' left of centerline, 1070' MSL.

22 FEB 2024 to 21 MAR 2024

22 FEB 2024 to 21 MAR 2024

TAKEOFF MINIMUMS, (OBSTACLE) DEPARTURE PROCEDURES, AND DIVERSE VECTOR AREA (RADAR VECTORS)

23278

EC-3

TAKEOFF MINIMUMS, (OBSTACLE) DEPARTURE PROCEDURES, AND DIVERSE VECTOR AREA (RADAR VECTORS)

23278

EFFINGHAM, IL

EFFINGHAM COUNTY MEML (1H2)

TAKEOFF MINIMUMS AND (OBSTACLE) DEPARTURE PROCEDURES AMDT 5B 22APR21 (21224) (FAA)

TAKEOFF MINIMUMS:

Rwy 1, std. w/min. climb of 235' per NM to 1300 or 1000-3 for VCOA.

DEPARTURE PROCEDURE:

Rwy 1, climb on heading 009° to 1400 before proceeding on course.

Rwy 29, climb on heading 294° to 1100 before proceeding on course.

VCOA:

Rwy 1, obtain ATC approval for VCOA when requesting IFR clearance. Climb in visual conditions to cross Effingham County Meml airport at or above 1400 before proceeding on course.

TAKEOFF OBSTACLE NOTES:

Rwy 1, sign 4' from DER, 208' left of centerline, 3' AGL/581' MSL.
Sign 14' from DER, 51' left of centerline, 55' AGL/581' MSL.
Building 156' from DER, 355' left of centerline, 6' AGL/585' MSL.
Tree 186' from DER, 475' right of centerline, 587' MSL.
Tree 188' from DER, 333' right of centerline, 18' AGL/591' MSL.
Tree 224' from DER, 245' right of centerline, 592' MSL.
Tree 238' from DER, 500' right of centerline, 593' MSL.
Tree 270' from DER, 365' right of centerline, 617' MSL.
Building 283' from DER, 474' left of centerline, 29' AGL/609' MSL.
Tree 313' from DER, 583' right of centerline, 630' MSL.
Tree 358' from DER, 417' right of centerline, 648' MSL.
Pole 370' from DER, 546' left of centerline, 28' AGL/608' MSL.
Tree 384' from DER, 313' right of centerline, 637' MSL.
Building 384' from DER, 418' left of centerline, 600' MSL.
Tree 405' from DER, 50' left of centerline, 593' MSL.
Tree 430' from DER, 578' right of centerline, 644' MSL.
Vehicle on road 467' from DER, 173' left of centerline, 595' MSL.
Tree 477' from DER, 302' left of centerline, 646' MSL.
Tree 494' from DER, 516' left of centerline, 632' MSL.
Tree 503' from DER, 64' right of centerline, 598' MSL.
Tree 553' from DER, 281' right of centerline, 600' MSL.
Tree 563' from DER, 651' left of centerline, 614' MSL.
Tree 620' from DER, 387' left of centerline, 608' MSL.
Tree 666' from DER, 588' left of centerline, 618' MSL.
Pole 713' from DER, 422' left of centerline, 25' AGL/604' MSL.
Tree 721' from DER, 150' right of centerline, 613' MSL.
Tree 782' from DER, 631' left of centerline, 646' MSL.
Tree 814' from DER, 203' right of centerline, 616' MSL.
Elevator 821' from DER, 491' left of centerline, 72' AGL/654' MSL.
Tree 824' from DER, 8' left of centerline, 624' MSL.
Tree 872' from DER, 687' left of centerline, 612' MSL.
Building 877' from DER, 282' left of centerline, 30' AGL/609' MSL.
Building 925' from DER, 453' left of centerline, 27' AGL/607' MSL.
Tree 946' from DER, 163' left of centerline, 622' MSL.
Tree 947' from DER, 85' right of centerline, 626' MSL.
Tree 1046' from DER, 168' left of centerline, 628' MSL.
Tree 2212' from DER, 1049' right of centerline, 636' MSL.
Rwy 11, tree 15' from DER, 153' right of centerline, 574' MSL.
Tree 22' from DER, 363' left of centerline, 48' AGL/619' MSL.
Tree 103' from DER, 166' left of centerline, 575' MSL.
Tree 1311' from DER, 758' left of centerline, 659' MSL.
Tree 1355' from DER, 663' left of centerline, 660' MSL.
Tree 1483' from DER, 720' left of centerline, 652' MSL.
Tree 1494' from DER, 873' left of centerline, 660' MSL.
Tree 1590' from DER, 676' left of centerline, 639' MSL.
Tree 1656' from DER, 773' left of centerline, 626' MSL.
Tree 1699' from DER, 839' right of centerline, 617' MSL.
Tree 1782' from DER, 685' left of centerline, 662' MSL.
Tree 1873' from DER, 854' right of centerline, 635' MSL.
Tree 1887' from DER, 786' left of centerline, 640' MSL.
Tree 1923' from DER, 413' left of centerline, 642' MSL.
Tree 1950' from DER, 699' left of centerline, 641' MSL.
Tree 1951' from DER, 868' left of centerline, 652' MSL.
Tree 2048' from DER, 830' left of centerline, 629' MSL.
Tree 2052' from DER, 568' left of centerline, 626' MSL.
Tree 2156' from DER, 772' left of centerline, 634' MSL.
Tree 2195' from DER, 974' left of centerline, 658' MSL.
Tree 2235' from DER, 600' left of centerline, 636' MSL.
Tree 2306' from DER, 1002' left of centerline, 648' MSL.
Tree 2324' from DER, 281' right of centerline, 634' MSL.
Tree 2338' from DER, 380' left of centerline, 635' MSL.
Tree 2390' from DER, 621' left of centerline, 643' MSL.

CONT'

TAKEOFF MINIMUMS, (OBSTACLE) DEPARTURE PROCEDURES, AND DIVERSE VECTOR AREA (RADAR VECTORS)

23278

**TAKEOFF MINIMUMS, (OBSTACLE) DEPARTURE PROCEDURES, AND
DIVERSE VECTOR AREA (RADAR VECTORS)**

23278

EFFINGHAM, IL (CON'T)**EFFINGHAM COUNTY MEML (1H2) (CON'T)****Rwy 11 (CON'T)**, tree 2418' from DER, 209' right of centerline, 641' MSL.

Tree 2457' from DER, 1086' left of centerline, 636' MSL.

Tree 2461' from DER, 394' right of centerline, 636' MSL.

Tree 2494' from DER, 627' left of centerline, 642' MSL.

Tree 2533' from DER, 458' left of centerline, 642' MSL.

Tree 2636' from DER, 1125' right of centerline, 644' MSL.

Tree 2649' from DER, 613' left of centerline, 639' MSL.

Tree 2746' from DER, 738' left of centerline, 641' MSL.

Tree 2813' from DER, 551' left of centerline, 644' MSL.

Rwy 19, tree 37' from DER, 461' right of centerline, 620' MSL.

Tree 79' from DER, 468' left of centerline, 63' AGL/627' MSL.

Tree 107' from DER, 229' left of centerline, 612' MSL.

Tree 133' from DER, 400' right of centerline, 627' MSL.

Tree 167' from DER, 346' left of centerline, 615' MSL.

Tree 202' from DER, 524' right of centerline, 638' MSL.

Tree 314' from DER, 392' right of centerline, 624' MSL.

tree 321' from DER, 494' right of centerline, 625' MSL.

Tree 351' from DER, 505' left of centerline, 640' MSL.

Tree 417' from DER, 390' right of centerline, 616' MSL.

Tree 446' from DER, 563' right of centerline, 641' MSL.

Tree 454' from DER, 541' left of centerline, 636' MSL.

Tree 515' from DER, 632' left of centerline, 603' MSL.

Tree 546' from DER, 431' left of centerline, 633' MSL.

Tree 547' from DER, 497' right of centerline, 633' MSL.

Tree 549' from DER, 329' right of centerline, 625' MSL.

Tree 556' from DER, 626' right of centerline, 631' MSL.

Tree 688' from DER, 483' left of centerline, 610' MSL.

Tree 717' from DER, 132' left of centerline, 597' MSL.

Tree 877' from DER, 499' right of centerline, 638' MSL.

Tree 881' from DER, 96' left of centerline, 604' MSL.

Tree 926' from DER, 651' right of centerline, 651' MSL.

Tree 965' from DER, 654' left of centerline, 636' MSL.

Tree 986' from DER, 538' right of centerline, 649' MSL.

Tree 1059' from DER, 590' left of centerline, 623' MSL.

Tree 1239' from DER, 607' left of centerline, 613' MSL.

Tree 1270' from DER, 421' left of centerline, 630' MSL.

Tree 1357' from DER, 585' left of centerline, 638' MSL.

Tree 1430' from DER, 275' left of centerline, 625' MSL.

Tree 1454' from DER, 440' left of centerline, 642' MSL.

Tree 1459' from DER, 676' left of centerline, 647' MSL.

Tree 1475' from DER, 171' left of centerline, 629' MSL.

Tree 1518' from DER, 233' right of centerline, 641' MSL.

Tree 1521' from DER, 315' left of centerline, 638' MSL.

Tree 1522' from DER, 759' left of centerline, 642' MSL.

Tree 1526' from DER, 374' right of centerline, 655' MSL.

Tree 1532' from DER, 76' left of centerline, 643' MSL.

Tree 1538' from DER, 651' right of centerline, 628' MSL.

Tree 1545' from DER, 105' right of centerline, 647' MSL.

Tree 1546' from DER, 793' right of centerline, 635' MSL.

Tree 1619' from DER, 330' right of centerline, 647' MSL.

Tree 1627' from DER, 898' left of centerline, 640' MSL.

Tree 1631' from DER, 635' left of centerline, 637' MSL.

Tree 1665' from DER, 129' right of centerline, 645' MSL.

Tree 1721' from DER, 217' right of centerline, 642' MSL.

Tree 1758' from DER, 374' right of centerline, 640' MSL.

Tree 1773' from DER, 930' left of centerline, 657' MSL.

Tree 1829' from DER, 805' left of centerline, 658' MSL.

Tree 1908' from DER, 573' left of centerline, 631' MSL.

Tree 2016' from DER, 475' left of centerline, 633' MSL.

Tree 2017' from DER, 1005' left of centerline, 640' MSL.

Tree 2065' from DER, 853' left of centerline, 647' MSL.

Tree 2181' from DER, 753' left of centerline, 643' MSL.

Tree 2241' from DER, 899' left of centerline, 649' MSL.

Tree 2297' from DER, 1020' left of centerline, 644' MSL.

Tree 2408' from DER, 793' left of centerline, 640' MSL.

Tree 2433' from DER, 1050' left of centerline, 641' MSL.

Tree 2456' from DER, 893' left of centerline, 638' MSL.

Tree 2731' from DER, 1089' left of centerline, 641' MSL.

Tree 2759' from DER, 769' left of centerline, 644' MSL.

Rwy 29, electrical system 8' from DER, 352' right of centerline, 1' AGL/588' MSL.

Pole 925' from DER, 630' right of centerline, 32' AGL/612' MSL.

Tree 1043' from DER, 650' right of centerline, 627' MSL.

Pole 1104' from DER, 562' right of centerline, 34' AGL/613' MSL.

22 FEB 2024 to 21 MAR 2024

22 FEB 2024 to 21 MAR 2024

**TAKEOFF MINIMUMS, (OBSTACLE) DEPARTURE PROCEDURES, AND
DIVERSE VECTOR AREA (RADAR VECTORS)**

23278

TAKEOFF MINIMUMS, (OBSTACLE) DEPARTURE PROCEDURES, AND DIVERSE VECTOR AREA (RADAR VECTORS)

23278

EPHRAIM, WI

EPHRAIM/GIBRALTAR (3D2)

TAKEOFF MINIMUMS AND (OBSTACLE) DEPARTURE PROCEDURES

ORIG-A 07SEP23 (23250) (FAA)

TAKEOFF MINIMUMS:

Rwys 1, 19, NA- Environmental.

TAKEOFF OBSTACLE NOTES:

Rwy 14, utility poles, trees beginning 3' from DER, 90' left of centerline, up to 34' AGL/781' MSL.

Trees beginning 71' from DER, 162' right of centerline, up to 770' MSL.

Trees, utility poles beginning 302' from DER, 340' left of centerline, up to 804' MSL.

Tree 509' from DER, 586' right of centerline, 771' MSL.

Trees beginning 1039' from DER, 211' left of centerline, up to 81' AGL/810' MSL.

Tree 1071' from DER, 439' right of centerline, 783' MSL.

Tree 1362' from DER, 587' right of centerline, 791' MSL.

Trees beginning 1554' from DER, 161' right of centerline, up to 793' MSL.

Tree 1650' from DER, 590' right of centerline, 800' MSL.

Tree 1693' from DER, 275' right of centerline, 802' MSL.

Rwy 32, electrical system 10' from DER, 50' right of centerline, 5' AGL/764' MSL.

Tree 29' from DER, 296' right of centerline, 796' MSL.

Tree 90' from DER, 130' left of centerline, 769' MSL.

Trees beginning 123' from DER, 77' right of centerline, up to 805' MSL.

Tree 174' from DER, 289' left of centerline, 775' MSL.

Trees beginning 175' from DER, 333' left of centerline, up to 790' MSL.

Trees beginning 354' from DER, 3' left of centerline, up to 808' MSL.

Trees beginning 991' from DER, 4' right of centerline, up to 820' MSL.

Tree 1794' from DER, 841' left of centerline, 810' MSL.

Trees beginning 1813' from DER, 106' left of centerline, up to 813' MSL.

Trees beginning 1826' from DER, 276' left of centerline, up to 815' MSL.

Trees beginning 1969' from DER, 40' left of centerline, up to 819' MSL.

Trees beginning 2113' from DER, 381' left of centerline, up to 836' MSL.

FAIRFIELD, IL

FAIRFIELD MUNI (FWC)

TAKEOFF MINIMUMS AND (OBSTACLE) DEPARTURE PROCEDURES

AMDT 3 03JAN19 (19003) (FAA)

TAKEOFF MINIMUMS:

Rwy 9, 400-1% or std. w/min. climb of 370' per NM to 900.

TAKEOFF OBSTACLE NOTES:

Rwy 9, sign 16' from DER, 125' left of centerline, 414' MSL.

Vehicles beginning 341' from DER, 270' right of centerline, up to 427' MSL.

Pole, vehicles beginning 498' from DER, 122' right of centerline, up to 22' AGL/432' MSL.

Pole 504' from DER, 569' left of centerline, 17' AGL/429' MSL.

Poles beginning 673' from DER, 380' left of centerline, up to 36' AGL/446' MSL.

Pole 801' from DER, 212' right of centerline, 32' AGL/442' MSL.

Tree, pole beginning 803' from DER, 180' left of centerline, up to 452' MSL.

Poles beginning 864' from DER, 26' right of centerline, up to 36' AGL/444' MSL.

Trees beginning 1350' from DER, 296' left of centerline, up to 465' MSL.

Trees beginning 1558' from DER, 241' right of centerline, up to 468' MSL.

Trees beginning 1599' from DER, 608' right of centerline, up to 478' MSL.

Tree 1702' from DER, 859' right of centerline, 483' MSL.

Tree 2113' from DER, 853' left of centerline, 467' MSL.

Trees beginning 2206' from DER, 175' right of centerline, up to 496' MSL.

Tree 2270' from DER, 578' left of centerline, 474' MSL.

Trees beginning 2454' from DER, 163' right of centerline, up to 504' MSL.

Trees beginning 3393' from DER, 150' right of centerline, up to 507' MSL.

Terrain 4501' from DER, 1704' left of centerline, 534' MSL.

Terrain 4740' from DER, 1706' left of centerline, 540' MSL.

Tower, trees, tank beginning 4792' from DER, 511' left of centerline, up to 166' AGL/598' MSL.

Tower 1.1 NM from DER, 999' left of centerline, 281' AGL/732' MSL.

Tower 1.2 NM from DER, 2435' left of centerline, 243' AGL/703' MSL.

Rwy 18, terrain abeam DER, 278' right of centerline, 414' MSL.

Vehicles beginning 32' from DER, 198' left of centerline, up to 427' MSL.

Tree, fence beginning 97' from DER, 198' right of centerline, up to 424' MSL.

Pole 223' from DER, 400' left of centerline, 21' AGL/431' MSL.

Pole, vehicles beginning 336' from DER, 144' left of centerline, up to 22' AGL/432' MSL.

NAVAID 418' from DER, 446' right of centerline, 13' AGL/425' MSL.

Pole, vehicles beginning 453' from DER, 66' left of centerline, up to 23' AGL/433' MSL.

CON'T

22 FEB 2024 to 21 MAR 2024

22 FEB 2024 to 21 MAR 2024

TAKEOFF MINIMUMS, (OBSTACLE) DEPARTURE PROCEDURES, AND DIVERSE VECTOR AREA (RADAR VECTORS)

23278

EC-3

TAKEOFF MINIMUMS, (OBSTACLE) DEPARTURE PROCEDURES, AND DIVERSE VECTOR AREA (RADAR VECTORS)

23278

FAIRFIELD, IL (CON'T)

FAIRFIELD MUNI (FWC) (CON'T)

Rwy 27, fence 92' from DER, 319' left of centerline, 3' AGL/438' MSL.
 Vehicles 120' from DER, 297' right of centerline, 15' AGL/445' MSL.
 Vehicles 208' from DER, 296' right of centerline, 448' MSL.
 Vehicles beginning 320' from DER, 296' right of centerline, up to 450' MSL.
 Building 519' from DER, 593' left of centerline, 26' AGL/455' MSL.
 Vehicles 536' from DER, 440' right of centerline, 451' MSL.
 Vehicles beginning 538' from DER, 17' right of centerline, up to 452' MSL.
 Tree 609' from DER, 580' left of centerline, 491' MSL.
 Tree 764' from DER, 666' left of centerline, 500' MSL.
 Trees beginning 811' from DER, 495' left of centerline, up to 83' AGL/511' MSL.
 Trees beginning 1069' from DER, 476' left of centerline, up to 512' MSL.
 Tree 1178' from DER, 469' left of centerline, 513' MSL.
 Building 1198' from DER, 605' right of centerline, 19' AGL/465' MSL.
 Trees beginning 1291' from DER, 325' left of centerline, up to 514' MSL.
 Trees beginning 1885' from DER, 283' left of centerline, up to 530' MSL.
 Trees beginning 2303' from DER, 2' left of centerline, up to 83' AGL/531' MSL.
 Trees beginning 2514' from DER, 492' right of centerline, up to 529' MSL.
 Trees beginning 2588' from DER, 23' right of centerline, up to 534' MSL.
 Tree 2624' from DER, 869' right of centerline, 541' MSL.
 Trees beginning 2627' from DER, 154' right of centerline, up to 543' MSL.
 Trees beginning 2788' from DER, 13' right of centerline, up to 545' MSL.
 Trees beginning 4003' from DER, 597' right of centerline, up to 546' MSL.
 Trees 4615' from DER, 1724' left of centerline, 100' AGL/553' MSL.
 Trees 4854' from DER, 1726' left of centerline, 100' AGL/557' MSL.

FLORA, IL

FLORA MUNI (FOA)

TAKEOFF MINIMUMS AND (OBSTACLE) DEPARTURE PROCEDURES

AMDT 2 18NOV10 (22055) (FAA)

TAKEOFF MINIMUMS:

Rwys 15, 33, NA-Environmental.

TAKEOFF OBSTACLE NOTES:

Rwy 3, trees beginning 198' from DER, 55' left of centerline. Up to 99' AGL/554' MSL.
 Pole 897' from DER, 389' left of centerline, 29' AGL/493' MSL.
 Vehicle on road beginning 293' from DER, 55' left of centerline, 15' AGL/479' MSL.
 Trees beginning 59' from DER, 312' right of centerline, up to 99' AGL/537' MSL.
Rwy 21, vehicle on road beginning 11' from DER, 445' left of centerline, up to 15' AGL/488' MSL.
 Trees beginning 2730' from DER, 29' left of centerline, up to 98' AGL/572' MSL.
 Tree 2785' from DER, 108' right of centerline, 99' AGL/547' MSL.

FOND DU LAC, WI

FOND DU LAC COUNTY (FLD)

TAKEOFF MINIMUMS AND (OBSTACLE) DEPARTURE PROCEDURES

AMDT 1B 17OCT13 (13290) (FAA)

DEPARTURE PROCEDURE:

Rwy 9, climb runway heading to 2000 before turning north.
Rwy 36, climb runway heading to 2000 before turning east.

FORT ATKINSON, WI

FORT ATKINSON MUNI (61C)

TAKEOFF MINIMUMS AND (OBSTACLE) DEPARTURE PROCEDURES

AMDT 1 06FEB14 (14037) (FAA)

TAKEOFF MINIMUMS:

Rwy 3, 300-1½ or std. w/min. climb of 242' per NM to 1100', or alternatively, with standard takeoff minimums and a normal 200' per NM climb gradient, takeoff must occur no later than 2100' prior to DER.

TAKEOFF OBSTACLE NOTES:

Rwy 3, obstruction light on water tower 1.2 miles from DER, 2213' left of centerline, 144' AGL/994' MSL.
 Tank 1.2 miles from DER, 2203' left of centerline, 144' AGL/993' MSL.
 Trees beginning 412' from DER, 34' left of centerline, up to 100' AGL/884' MSL.
 Trees beginning 930' from DER, 40' right of centerline, up to 100' AGL/882' MSL.
 Buildings beginning 544' from DER, 479' left of centerline, up to 29' AGL/835' MSL.
 Buildings beginning 786' from DER, 694' right of centerline, up to 22' AGL/817' MSL.
 Vehicle on road 670' from DER, 57' left of centerline, up to 15' AGL/814' MSL.
Rwy 21, trees beginning 183' from DER, 380' right of centerline, up to 100' AGL/876' MSL.
 Trees beginning 1816' from DER, 698' left of centerline, up to 100' AGL/872' MSL.
 Sign 782' from DER, 684' right of centerline, 36' AGL/835' MSL.
 Vehicle on road 34' from DER, 81' left of centerline, up to 15' AGL/808' MSL.

TAKEOFF MINIMUMS, (OBSTACLE) DEPARTURE PROCEDURES, AND DIVERSE VECTOR AREA (RADAR VECTORS)

23278

EC-3

TAKEOFF MINIMUMS, (OBSTACLE) DEPARTURE PROCEDURES, AND DIVERSE VECTOR AREA (RADAR VECTORS)

23278

FREEPORT, IL

ALBERTUS (FEP)

TAKEOFF MINIMUMS AND (OBSTACLE) DEPARTURE PROCEDURES

ORIG 10MAY07 (07130) (FAA)

TAKEOFF MINIMUMS:

Rwys 13, 18, 31, 36, NA-Environmental.

TAKEOFF OBSTACLE NOTES:

Rwy 24, multiple trees beginning 446' from DER, 450' right of centerline, up to 67' AGL/903' MSL.

FRIENDSHIP (ADAMS), WI

ADAMS COUNTY LEGION FLD (63C)

TAKEOFF MINIMUMS AND (OBSTACLE) DEPARTURE PROCEDURES

AMDT 2 30JAN20 (22083) (FAA)

TAKEOFF MINIMUMS:

Rwys 8, 26, NA-Unsurveyed turf runways.**Rwy 33**, 500-2¼ or std. w/min. climb of 375' per NM to 1500.

DEPARTURE PROCEDURES:

Rwy 33, climb on heading 335° to 1600 before turning left.

TAKEOFF OBSTACLE NOTES:

Rwy 15, tree 94' from DER, 417' right of centerline, 1022' MSL.

Tree 195' from DER, 446' right of centerline, 1034' MSL.

Trees beginning 233' from DER, 498' right of centerline, up to 1039' MSL.

Tree 569' from DER, 586' left of centerline, 1012' MSL.

Trees beginning 608' from DER, 243' left of centerline, up to 1033' MSL.

Trees, towers, pole beginning 769' from DER, 216' left of centerline, up to 1038' MSL.

Trees, tower beginning 1395' from DER, 291' left of centerline, up to 1039' MSL.

Pole, tower, trees beginning 1614' from DER, 334' left of centerline, up to 63' AGL/1043' MSL.

Trees, pole beginning 1769' from DER, 105' left of centerline, up to 1053' MSL.

Trees beginning 1857' from DER, 225' right of centerline, up to 1040' MSL.

Trees beginning 2104' from DER, 78' right of centerline, up to 1044' MSL.

Trees beginning 2228' from DER, 25' right of centerline, up to 1045' MSL.

Trees beginning 2552' from DER, 331' left of centerline, up to 1059' MSL.

Trees beginning 2735' from DER, 211' left of centerline, up to 1067' MSL.

Rwy 33, trees beginning 155' from DER, 492' right of centerline, up to 1014' MSL.

Pole, building beginning 195' from DER, 379' left of centerline, up to 32' AGL/995' MSL.

Tree 657' from DER, 665' right of centerline, 1019' MSL.

Trees beginning 715' from DER, 49' right of centerline, up to 1024' MSL.

Trees beginning 951' from DER, 45' left of centerline, up to 1004' MSL.

Trees beginning 1064' from DER, 87' left of centerline, up to 1007' MSL.

Trees beginning 1299' from DER, 78' right of centerline, up to 1028' MSL.

Trees beginning 1406' from DER, 296' left of centerline, up to 1027' MSL.

Trees, pole beginning 1483' from DER, 73' left of centerline, up to 1045' MSL.

Trees beginning 1594' from DER, right of centerline, up to 1036' MSL.

Tree 2652' from DER, 915' right of centerline, 1056' MSL.

Mountain with trees, buildings, and towers beginning 1.2 NM from DER, 2068' left of centerline up to 1412' MSL.

GALESBURG, IL

GALESBURG MUNI (GBG)

TAKEOFF MINIMUMS AND (OBSTACLE) DEPARTURE PROCEDURES

ORIG 29JUL10 (10210) (FAA)

TAKEOFF OBSTACLE NOTES:

Rwy 3, trees beginning 1372' from DER, 352' right of centerline to 752' right of centerline, up to 55' AGL/819' MSL.**Rwy 10**, trees beginning 326' from DER, 154' right of centerline to 764' left of centerline, up to 63' AGL/820' MSL. Light

3969' from DER, 700' left of centerline 106' AGL/863' MSL.

Rwy 21, trees beginning 361' from DER, 496' left of centerline, to 657' right of centerline, up to 42' AGL/796' MSL. **Rwy 28**,

trees beginning 79' from DER, 138' left of centerline, to 330' right of centerline, up to 29' AGL/786' MSL. Pole 1204' from

DER, 372' right of centerline 32' AGL/789' MSL.

GRANTSBURG, WI

GRANTSBURG MUNI (GTG)

TAKEOFF MINIMUMS AND (OBSTACLE) DEPARTURE PROCEDURES

ORIG-A 20SEP12 (12264) (FAA)

TAKEOFF MINIMUMS:

Rwys 5, 23, NA - Environmental.

TAKEOFF OBSTACLE NOTES:

Rwy 12, trees beginning 154' from DER, 4' left of centerline, up to 102' AGL/1026' MSL.

Vehicle on road beginning 178' from DER, 48' left of centerline, 15' AGL/938' MSL.

Trees beginning 331' from DER, 34' right of centerline, up to 106' AGL/1030' MSL.

Vehicle on road beginning 204' from DER, 306' right of centerline, 15' AGL/943' MSL.

Rwy 30, trees beginning 164' from DER, 181' left of centerline, up to 69' AGL/993' MSL.

Vehicle on road beginning 375' from DER, 451' left of centerline, 15' AGL/940' MSL.

Trees beginning 112' from DER, 199' right of centerline, up to 24' AGL/948' MSL.

Vehicle on road beginning 59' from DER, 30' right of centerline, 15' AGL/937' MSL.

TAKEOFF MINIMUMS, (OBSTACLE) DEPARTURE PROCEDURES, AND DIVERSE VECTOR AREA (RADAR VECTORS)

23278

EC-3

TAKEOFF MINIMUMS, (OBSTACLE) DEPARTURE PROCEDURES, AND DIVERSE VECTOR AREA (RADAR VECTORS)

23278

GRAYSLAKE, IL

CAMPBELL (C81)

TAKEOFF MINIMUMS AND (OBSTACLE) DEPARTURE PROCEDURES
AMDT 1 04MAR82 (82063) (FAA)

TAKEOFF MINIMUMS:

Rwy 24, 300-1.

DEPARTURE PROCEDURE:

Rwy 9, climb runway heading to 1200 before turning.

GREEN BAY, WI

GREEN BAY/AUSTIN STRAUBEL INTL (GRB)

TAKEOFF MINIMUMS AND (OBSTACLE) DEPARTURE PROCEDURES
AMDT 2A 17AUG17 (21336) (FAA)

DEPARTURE PROCEDURE:

Rwy 6, climb heading 062° to 1300 before turning right.**Rwy 18**, climb heading 182° to 1600 before turning left.

TAKEOFF OBSTACLE NOTES:

Rwy 18, tree 3022' from DER, 680' left of centerline, 100' AGL/779' MSL.**Rwy 24**, trees beginning 1556' from DER, 893' left of centerline, up to 100' AGL/779' MSL.

Pole 1114' from DER, 665' left of centerline, 38' AGL/722' MSL.

GREENVILLE, IL

GREENVILLE (GRE)

TAKEOFF MINIMUMS AND (OBSTACLE) DEPARTURE PROCEDURES
ORIG 11MAR10 (10070) (FAA)

TAKEOFF MINIMUMS:

Rwys 9, 27, NA-Environmental.

TAKEOFF OBSTACLE NOTES:

Rwy 18, vehicle on road at DER, 376' left of centerline, up to 15' AGL/554' MSL.

Trees beginning 534' from DER, 491' right of centerline, up to 100' AGL/639' MSL.

Trees beginning 3097' from DER, 54' left of centerline, 100' AGL/629' MSL.

Rwy 36, vehicle on road at DER, 393' right of centerline, up to 15' AGL/554' MSL.

GREENWOOD/WONDER LAKE, IL

GALT FLD (10C)

TAKEOFF MINIMUMS AND (OBSTACLE) DEPARTURE PROCEDURES
ORIG 10MAR11 (21224) (FAA)

TAKEOFF MINIMUMS:

Rwys 18, 36, NA-Environmental.

TAKEOFF OBSTACLE NOTES:

Rwy 9, terrain rising 31' from DER, left and right of centerline, up to 857' MSL.

Trees and PVC pipe in concrete beginning 627' from DER, 230' left of centerline, up to 100' AGL/519' MSL.

Tree 895' from DER, 523' right of centerline, 61' AGL/454' MSL.

Tree 5590' from DER, 1383' left of centerline, 100' AGL/539' MSL.

Rwy 14, vehicle 368' from DER, 594' right of centerline, 15' AGL/394' MSL.

Trees beginning 3343' from DER, 1286' left of centerline, up to 100' AGL/509' MSL.

Rwy 24, trees beginning 919' from DER, 487' right of centerline, up to 100' AGL/509' MSL.

Trees beginning 1706' from DER, 420' right of centerline, up to 100' AGL/519' MSL.

Rwy 32, vehicle 482' from DER, 609' left of centerline, 15' AGL/414' MSL.

Trees beginning 1087' from DER, 207' left of centerline, up to 100' AGL/509' MSL.

Trees beginning 1616' from DER, 45' right of centerline, up to 100' AGL/509' MSL.

HARRISBURG, IL

HARRISBURG-RALEIGH (HSB)

TAKEOFF MINIMUMS AND (OBSTACLE) DEPARTURE PROCEDURES
AMDT 1 23SEP10 (10266) (FAA)

TAKEOFF OBSTACLE NOTES:

Rwy 6, trees beginning 62' from DER, 257' left of centerline, up to 100' AGL/519' MSL.

Trees and PVC pipe in concrete beginning 627' from DER, 230' left of centerline, up to 100' AGL/519' MSL.

Tree 895' from DER, 523' right of centerline, 61' AGL/454' MSL.

Tree 5590' from DER, 1383' left of centerline, 100' AGL/539' MSL.

Rwy 14, vehicle 368' from DER, 594' right of centerline, 15' AGL/394' MSL.

Trees beginning 3343' from DER, 1286' left of centerline, up to 100' AGL/509' MSL.

Rwy 24, trees beginning 919' from DER, 487' right of centerline, up to 100' AGL/509' MSL.

Trees beginning 1706' from DER, 420' right of centerline, up to 100' AGL/519' MSL.

Rwy 32, vehicle 482' from DER, 609' left of centerline, 15' AGL/414' MSL.

Trees beginning 1087' from DER, 207' left of centerline, up to 100' AGL/509' MSL.

Trees beginning 1616' from DER, 45' right of centerline, up to 100' AGL/509' MSL.

TAKEOFF MINIMUMS, (OBSTACLE) DEPARTURE PROCEDURES, AND DIVERSE VECTOR AREA (RADAR VECTORS)

23278

EC-3

TAKEOFF MINIMUMS, (OBSTACLE) DEPARTURE PROCEDURES, AND DIVERSE VECTOR AREA (RADAR VECTORS)

23278

HARTFORD, WI

HARTFORD MUNI (HXF)

TAKEOFF MINIMUMS AND (OBSTACLE) DEPARTURE PROCEDURES

AMDT 1 26MAR20 (20086) (FAA)

TAKEOFF MINIMUMS:

Rwys 18, 36, NA - Environmental.

TAKEOFF OBSTACLE NOTES:

Rwy 9, terrain beginning 186' from DER, 381' left of centerline, up to 1084' MSL.

Terrain beginning 412' from DER, 399' left of centerline, up to 1087' MSL.

Terrain 598' from DER, 560' left of centerline, 1088' MSL.

Pole 1315' from DER, 209' left of centerline, 35' AGL/1110' MSL.

Pole 1316' from DER, 42' right of centerline, 31' AGL/1110' MSL.

Trees beginning 1458' from DER, 38' right of centerline, up to 1123' MSL.

Trees beginning 1608' from DER, 27' right of centerline, up to 1136' MSL.

Transmission line 2808' from DER, 713' right of centerline, 95' AGL/1146' MSL.

Rwy 27, terrain beginning 13' from DER, 183' right of centerline, up to 1062' MSL.

Building 21' from DER, 471' left of centerline, 16' AGL/1058' MSL.

Building beginning 120' from DER, 402' left of centerline, up to 26' AGL/1069' MSL.

HAYWARD, WI

SAWYER COUNTY (HYR)

TAKEOFF MINIMUMS AND (OBSTACLE) DEPARTURE PROCEDURES

AMDT 5 20AUG15 (15232) (FAA)

TAKEOFF MINIMUMS:

Rwy 16, 34, NA-Environmental.

TAKEOFF OBSTACLE NOTES:

Rwy 3, trees and pole beginning 37' from DER, 163' left of centerline, up to 27' AGL/1238' MSL.

Trees beginning 106' from DER, 224' right of centerline, up to 50' AGL/1260' MSL.

Trees beginning 131' from DER, 311' left of centerline, up to 88' AGL/1298' MSL.

Trees beginning 262' from DER, 412' right of centerline, up to 77' AGL/1288' MSL.

Trees beginning 1818' from DER, crossing centerline, up to 100' AGL/1311' MSL.

Rwy 21, vehicles on road, pole, and NAVAID beginning 17' from DER, 91' right of centerline, up to 23' AGL/1224' MSL.

Tree 272' from DER, 416' left of centerline, 17' AGL/1218' MSL.

Trees, pole, and NAVAID beginning 326' from DER, 254' right of centerline, up to 86' AGL/1284' MSL.

Trees beginning 2344' from DER, crossing centerline, up to 100' AGL/1311' MSL.

JACKSONVILLE, IL

JACKSONVILLE MUNI (IJX)

TAKEOFF MINIMUMS AND (OBSTACLE) DEPARTURE PROCEDURES

ORIG 20OCT11 (11293) (FAA)

TAKEOFF OBSTACLE NOTES:

Rwy 13, trees beginning 811' from DER, 430' left of centerline, up to 100' AGL/708' MSL.

Power lines 705' from DER, crossing centerline, 40' AGL/655' MSL.

Rwy 22, trees beginning 2888' from DER, 259' left of centerline, up to 100' AGL/707' MSL.**Rwy 31**, trees beginning 2044' from DER, 823' right of centerline, up to 100' AGL/688' MSL.

JANESVILLE, WI

SOUTHERN WISCONSIN RGNL (JVL)

TAKEOFF MINIMUMS AND (OBSTACLE) DEPARTURE PROCEDURES

ORIG 10APR08 (08101) (FAA)

TAKEOFF MINIMUMS:

Rwy 36, 300-2¼ or std. w/ a min. climb of 203' per NM to 1200, or alternatively, with standard takeoff minimums and a normal 200'/NM climb gradient, takeoff must occur no later than 1200' prior to DER.

TAKEOFF OBSTACLE NOTES:

Rwy 4, road 342' from DER, 520' right of centerline, 17' AGL/846' MSL.

Trees beginning 624' from DER, 366' left of centerline, up to 60' AGL/889' MSL.

Light on pole 1290' from DER, 595' left of centerline, 21' AGL/840' MSL.

Antenna 804' from DER, 190' left of centerline, 16' AGL/825' MSL.

Rwy 32, tree 1524' from DER 857' left of centerline, 100' AGL/869' MSL.**Rwy 36**, tree 1427' from DER, 108' left of centerline, 42' AGL/851' MSL.

Road 385' from DER, 20' left of centerline, 15' AGL/824' MSL.

Tower 1.92 NM from DER, 1427' left of centerline, 258' AGL/1101' MSL.

JUNEAU, WI

DODGE COUNTY (UNU)

TAKEOFF MINIMUMS AND (OBSTACLE) DEPARTURE PROCEDURES

ORIG-A 12AUG21 (21224) (FAA)

TAKEOFF MINIMUMS:

Rwy 20, 300-1 or std. w/min. climb of 446' per NM to 1200.

CON'T

TAKEOFF MINIMUMS, (OBSTACLE) DEPARTURE PROCEDURES, AND DIVERSE VECTOR AREA (RADAR VECTORS)

23278

TAKEOFF MINIMUMS, (OBSTACLE) DEPARTURE PROCEDURES, AND DIVERSE VECTOR AREA (RADAR VECTORS)

23278

JUNEAU, WI (CON'T) DODGE COUNTY (UNU) (CON'T)

TAKEOFF OBSTACLE NOTES:

Rwy 2, trees beginning 509' from DER, 526' left of centerline, up to 969' MSL.
Wind indicator, pole beginning 517' from DER, 394' right of centerline, up to 958' MSL.
Pole 561' from DER, 536' right of centerline, 36' AGL/969' MSL.
Trees, pole beginning 625' from DER, 309' right of centerline, up to 981' MSL.
Tree 795' from DER, 439' right of centerline, 984' MSL.
Tree, building beginning 862' from DER, 413' right of centerline, up to 989' MSL.
Trees, poles beginning 937' from DER, 311' right of centerline, up to 990' MSL.
Rwy 8, buildings beginning 375' from DER, 390' left of centerline, up to 27' AGL/966' MSL.
Buildings beginning 523' from DER, 441' left of centerline, up to 976' MSL.
Trees, pole beginning 567' from DER, 366' left of centerline, up to 988' MSL.
Tree 635' from DER, 466' right of centerline, 970' MSL.
Trees beginning 667' from DER, 340' right of centerline, up to 978' MSL.
Tree 699' from DER, 487' right of centerline, 981' MSL.
Trees beginning 735' from DER, 72' right of centerline, up to 982' MSL.
Tree, tower beginning 813' from DER, 609' right of centerline, up to 986' MSL.
Rwy 20, tower 4174' from DER, 1502' left of centerline, 174' AGL/1085' MSL.
Rwy 26, trees beginning 581' from DER, 111' right of centerline, up to 926' MSL.
Trees beginning 683' from DER, 162' right of centerline, up to 940' MSL.
Tree 736' from DER, 453' left of centerline, 929' MSL.
Tree 760' from DER, 687' left of centerline, 949' MSL.
Trees beginning 1112' from DER, 642' right of centerline, up to 952' MSL.
Trees, pole beginning 1138' from DER, 400' left of centerline, up to 966' MSL.
Trees beginning 1590' from DER, 453' right of centerline, up to 957' MSL.
Tree 1783' from DER, 538' right of centerline, 970' MSL.
Trees beginning 1796' from DER, 141' right of centerline, up to 995' MSL.
Trees beginning 2564' from DER, 351' left of centerline, up to 969' MSL.
Trees beginning 2829' from DER, 249' left of centerline, up to 972' MSL.
Tree 3459' from DER, 1284' right of centerline, 998' MSL.
Trees beginning 3582' from DER, 905' right of centerline, up to 1009' MSL.
Tree 3934' from DER, 93' left of centerline, 994' MSL.
Trees beginning 4242' from DER, 37' left of centerline, up to 1022' MSL.
Tree 4422' from DER, 266' left of centerline, 1030' MSL.
Trees beginning 4495' from DER, 42' left of centerline, up to 111' AGL/1036' MSL.
Tree 4603' from DER, on centerline, 84' AGL/1015' MSL.

KANKAKEE, IL

GREATER KANKAKEE (IKK)

TAKEOFF MINIMUMS AND (OBSTACLE) DEPARTURE PROCEDURES

AMDT 1 02MAY13 (13122) (FAA)

TAKEOFF OBSTACLE NOTES:

Rwy 4, trees beginning 1296' from DER, 303' left of centerline, up to 36' AGL/666' MSL.
Trees 2045' from DER, 231' left of centerline, 51' AGL/681' MSL.
Rwy 16, trees beginning 525' from DER, 162' left of centerline, up to 27' AGL/639' MSL.
Tree 2658' from DER, 1085' left of centerline, 81' AGL/698' MSL.
Rwy 34, trees beginning 72' from DER, 406' right of centerline, up to 26' AGL/647' MSL.
Trees beginning 501' from DER, 123' left of centerline, up to 51' AGL/672' MSL.
Tree 993' from DER, 664' left of centerline, 73' AGL/690' MSL.

KENOSHA, WI

KENOSHA RGNL (ENW)

TAKEOFF MINIMUMS AND (OBSTACLE) DEPARTURE PROCEDURES

AMDT 1 31DEC20 (20366) (FAA)

TAKEOFF OBSTACLE NOTES:

Rwy 7R, poles beginning 559' from DER, 342' right of centerline, up to 30' AGL/729' MSL.
Tree 569' from DER, 251' left of centerline, 722' MSL.
Trees, pole beginning 810' from DER, 248' left of centerline, up to 760' MSL.
Rwy 15, trees beginning 1604' from DER, 40' right of centerline, up to 100' AGL/809' MSL.
Trees beginning 1964' from DER, 173' left of centerline, up to 100' AGL/799' MSL.
Tree 2950' from DER, 22' left of centerline, 100' AGL/809' MSL.
Rwy 25L, buildings, tree beginning 10' from DER, 207' right of centerline, up to 20' AGL/760' MSL.
Trees, fence, vehicles on road beginning 21' from DER, 1' left of centerline, up to 763' MSL.
Poles, buildings beginning 464' from DER, 113' right of centerline, up to 50' AGL/799' MSL.
Building 1164' from DER, 388' left of centerline, 50' AGL/799' MSL.
Rwy 33, poles beginning 581' from DER, 455' right of centerline, up to 33' AGL/738' MSL.
Tree 808' from DER, 401' right of centerline, 778' MSL.
Trees beginning 868' from DER, 356' right of centerline, up to 786' MSL.
Trees beginning 960' from DER, 36' right of centerline, up to 792' MSL.
Tree 1171' from DER, 61' left of centerline, 771' MSL.
Trees beginning 1178' from DER, 525' left of centerline, up to 795' MSL.

CON'T

TAKEOFF MINIMUMS, (OBSTACLE) DEPARTURE PROCEDURES, AND DIVERSE VECTOR AREA (RADAR VECTORS)

23278

EC-3

TAKEOFF MINIMUMS, (OBSTACLE) DEPARTURE PROCEDURES, AND DIVERSE VECTOR AREA (RADAR VECTORS)

23278

KENOSHA, WI (CON'T)

KENOSHA RGNL (ENW) (CON'T)

- Rwy 33 (CON'T)**, trees beginning 1228' from DER, 77' left of centerline, up to 801' MSL.
Trees, poles beginning 1408' from DER, 139' left of centerline, up to 810' MSL.
Trees beginning 1430' from DER, 218' right of centerline, up to 800' MSL.
Trees beginning 3302' from DER, 165' right of centerline, up to 809' MSL.
Tree 3644' from DER, 351' right of centerline, 811' MSL.

KEWANEE, IL

KEWANEE MUNI (EZI)

TAKEOFF MINIMUMS AND (OBSTACLE) DEPARTURE PROCEDURES

ORIG-B 11AUG22 (22223) (FAA)

DEPARTURE PROCEDURE:

- Rwy 1**, climb on heading 013° to 1400 before turning west.
Rwy 27, climb on heading 273° before turning north.

TAKEOFF OBSTACLE NOTES:

- Rwy 1**, electrical system 9' from DER, 26' right of centerline, 1' AGL/838' MSL.
Tree 2154' from DER, 1026' right of centerline, 68' AGL/901' MSL.
Tree 2552' from DER, 990' left of centerline, 909' MSL.
Rwy 19, tower, building beginning 166' from DER, 486' left of centerline, up to 22' AGL/871' MSL.
Tree, pole beginning 685' from DER, 413' right of centerline, up to 887' MSL.
Rwy 27, tower, transmission line beginning 1417' from DER, 95' right of centerline, up to 69' AGL/917' MSL.
Transmission line 2606' from DER, 982' left of centerline, 75' AGL/920' MSL.
Elevator 2977' from DER, 794' right of centerline, 92' AGL/945' MSL.

LA CROSSE, WI

LA CROSSE RGNL (LSE)

TAKEOFF MINIMUMS AND (OBSTACLE) DEPARTURE PROCEDURES

AMDT 6A 08JAN15 (15008) (FAA)

TAKEOFF MINIMUMS:

- Rwy 4**, std. w/ min. climb of 460' per NM to 1700, or 1400-2½ for climb in visual conditions.
Rwy 13, std. w/ min. climb of 420' per NM to 2000, or 1400-2½ for climb in visual conditions.
Rwy 18, std. w/ min. climb of 400' per NM to 2200, or 1400-2½ for climb in visual conditions.
Rwy 22, std. w/ min. climb of 430' per NM to 2100, or 1400-2½ for climb in visual conditions.
Rwy 31, std. w/ min. climb of 340' per NM to 2500, or 1400-2½ for climb in visual conditions.
Rwy 36, std. w/ min. climb of 400' per NM to 2200, or 1400-2½ for climb in visual conditions.

DEPARTURE PROCEDURE:

- Rwys 4, 13, 18, 22, 31, 36**, for climb in visual conditions cross La Crosse Muni airport at or above 1900 MSL before proceeding on course.

TAKEOFF OBSTACLE NOTES:

- Rwy 4**, trees beginning 498' from DER, right and left of centerline, up to 100' AGL/799' MSL.
Pole 4371' from DER, 205' left of centerline, 84' AGL/784' MSL.
Rwy 13, trees beginning 423' from DER, right and left of centerline, up to 100' AGL/754' MSL.
Rwy 18, trees beginning 1337' from DER, right and left of centerline, up to 100' AGL/739' MSL.
Vehicles on road beginning 477' from DER, right and left of centerline, 15' AGL/694' MSL.
Rwy 22, vehicles on road and buildings beginning 478' from DER, right and left of centerline, up to 30' AGL/694' MSL.
Trees beginning 1436' from DER, 281' left of centerline, up to 100' AGL/735' MSL.
Light poles beginning 1503' from DER, 171' right of centerline, up to 35' AGL/695' MSL.
Rwy 31, trees beginning 967' from DER, right and left of centerline, up to 100' AGL/754' MSL.
Rwy 36, trees beginning 2910' from DER, right and left of centerline, up to 100' AGL/744' MSL.

LA POINTE, WI

MAJOR GILBERT FIELD (4R5)

TAKEOFF MINIMUMS AND (OBSTACLE) DEPARTURE PROCEDURES

ORIG 05JUN08 (08157) (FAA)

TAKEOFF MINIMUMS:

- Rwy 22**, 300-2 or std. w/ min. climb of 213' per NM to 1200.

DEPARTURE PROCEDURE:

- Rwy 22**, Climb heading 220° to 1200 before proceeding on course.

TAKEOFF OBSTACLE NOTES:

- Rwy 4**, trees beginning 69' from DER, 5' left of centerline, up to 100' AGL/759' MSL.
Trees beginning 340' from DER, 52' right of centerline, up to 100' AGL/759' MSL.
Rwy 22, trees beginning 1867' from DER, 187' left of centerline, up to 100' AGL/710' MSL.
Trees beginning 167' from DER, 23' right of centerline, up to 100' AGL/729' MSL.

TAKEOFF MINIMUMS, (OBSTACLE) DEPARTURE PROCEDURES, AND DIVERSE VECTOR AREA (RADAR VECTORS)

23278

EC-3

TAKEOFF MINIMUMS, (OBSTACLE) DEPARTURE PROCEDURES, AND DIVERSE VECTOR AREA (RADAR VECTORS)

23278

LACON, IL

MARSHALL COUNTY (C75)

TAKEOFF MINIMUMS AND (OBSTACLE) DEPARTURE PROCEDURES

AMDT 2 24AUG89 (89236) (FAA)

TAKEOFF MINIMUMS:

Rwys 13, 18, 36, 300-1.

DEPARTURE PROCEDURE:

Rwy 31, climb runway heading to 1800 before turning.

LADYSMITH, WI

RUSK COUNTY (RCX)

TAKEOFF MINIMUMS AND (OBSTACLE) DEPARTURE PROCEDURES

AMDT 1 15NOV12 (12320) (FAA)

TAKEOFF OBSTACLE NOTES:

Rwy 1, multiple trees 7' from DER, 420' right of centerline, up to 21' AGL/1271' MSL.

Multiple trees 127' from DER, 319' right of centerline, up to 3' AGL/1243' MSL.

Trees beginning 197' from DER, right and left of centerline, up to 100' AGL/1354' MSL.

Vehicles on road beginning 110' from DER, right and left of centerline, up to 17' AGL/1263' MSL.

NAVAID 493' from DER, 534' left of centerline, 15' AGL/1252' MSL.

Posts beginning 519' from DER, 387' left of centerline, up to 55' AGL/1296' MSL.

Pole 772' from DER, 453' right of centerline, 35' AGL/1282' MSL.

Rwy 14, sign 30' from DER, 485' right of centerline, 10' AGL/1228' MSL.

NAVAID 33' from DER, 124' right of centerline, 12' AGL/1232' MSL.

Trees beginning 84' from DER, 491' left of centerline, up to 75' AGL/1304' MSL.

Trees beginning 900' from DER, right and left of centerline, up to 75' AGL/1305' MSL.

Rwy 19, trees beginning 7' from DER, 28' right of centerline, up to 53' AGL/1285' MSL.

Vehicles on road 178' from DER, 349' right of centerline, 17' AGL/1234' MSL.

Trees beginning 1132' from DER, 779' left of centerline up to 65' AGL/1285' MSL.

Obstruction light on water tank and water tower beginning 3382' from DER, 1276' left of centerline, up to 134' AGL/1362' MSL.

Rwy 32, trees beginning 22' from DER, 427' right of centerline, up to 30' AGL/1267' MSL.

Trees beginning 137' from DER, right and left of centerline, up to 65' AGL/1301' MSL.

Vehicles on road beginning 109' from DER, 312' right of centerline, up to 17' AGL/ 1251' MSL.

Trees beginning 2458' from DER, 710' right of centerline, up to 100' AGL/1299' MSL.

LAKE GENEVA, WI

GRAND GENEVA RESORT (C02)

TAKEOFF MINIMUMS AND (OBSTACLE) DEPARTURE PROCEDURES

AMDT 1A 07DEC17 (17341) (FAA)

TAKEOFF MINIMUMS:

Rwy 5, 300-1¼ or 300-1 w/ min. climb of 260' per NM to 1100.

Rwy 23, 300-1¾ or 300-1 w/ min. climb of 310' per NM to 1200.

DEPARTURE PROCEDURE:

Rwy 23, climb on heading 237° to 1500 before turning right.

TAKEOFF OBSTACLE NOTES:

Rwy 5, trees beginning abeam DER, 51' right of centerline, up to 100' AGL/939' MSL.

Trees beginning 456' from DER, 167' right of centerline, up to 100' AGL/1019' MSL.

Trees beginning 1652' from DER, left and right of centerline, up to 100' AGL/969' MSL.

Trees beginning 2428' from DER, 459' left of centerline, up to 100' AGL/989' MSL.

Trees beginning 3408' from DER, 253' right of centerline, up to 100' AGL/979' MSL.

Trees beginning 4645' from DER, 1697' left of centerline, up to 100' AGL/959' MSL.

Trees beginning 5477' from DER, 1005' right of centerline, up to 100' AGL/1019' MSL.

Rwy 23, trees beginning abeam DER, 86' left of centerline, up to 100' AGL/949' MSL.

Trees beginning 333' from DER, 157' right of centerline, up to 100' AGL/949' MSL.

Trees beginning 1467' from DER, 581' left of centerline, up to 100' AGL/979' MSL.

Trees beginning 1559' from DER, 273' right of centerline, up to 100' AGL/1009' MSL.

Trees beginning 3094' from DER, 558' left of centerline, up to 100' AGL/1009' MSL.

Trees beginning 4099' from DER, left and right of centerline, up to 100' AGL/1039' MSL.

LAND O'LAKES, WI

KINGS LAND O'LAKES (LNL)

TAKEOFF MINIMUMS AND (OBSTACLE) DEPARTURE PROCEDURES

AMDT 5 07OCT21 (21280) (FAA)

TAKEOFF MINIMUMS:

Rwys 5, 23, NA-Environmental.

Rwy 32, 300-1¾ or std. w/min. climb of 250' per NM to 2000.

TAKEOFF OBSTACLE NOTES:

Rwy 14, pole 10' from DER, 47' left of centerline, 3' AGL/1705' MSL.

Vehicles on road and fence beginning 11' from DER, 260' left of centerline, up to 1724' MSL.

Vegetation 15' from DER, 121' right of centerline, 1706' MSL.

Tree 48' from DER, 423' right of centerline, 1754' MSL.

CON'T

TAKEOFF MINIMUMS, (OBSTACLE) DEPARTURE PROCEDURES, AND DIVERSE VECTOR AREA (RADAR VECTORS)

23278

TAKEOFF MINIMUMS, (OBSTACLE) DEPARTURE PROCEDURES, AND DIVERSE VECTOR AREA (RADAR VECTORS)

23278

LAND O'LAKES, WI (CON'T)

KINGS LAND O'LAKES (LNL) (CON'T)

Rwy 14 (CON'T), trees, fence, vehicles on road, sign, poles, and transmission line beginning 96' from DER, 31' left of centerline, up to 1769' MSL.

Trees and building beginning 122' from DER, 21' right of centerline, up to 1757' MSL.

Trees beginning 571' from DER, 72' right of centerline, up to 1758' MSL.

Trees beginning 1124' from DER, 17' right of centerline, up to 1760' MSL.

Trees beginning 1187' from DER, 33' right of centerline, up to 1774' MSL.

Trees beginning 1758' from DER, 83' right of centerline, up to 1781' MSL.

Tree 4729' from DER, 671' right of centerline, 1824' MSL.

Rwy 32, terrain 5' from DER, 265' right of centerline, 1706' MSL.

Vegetation beginning 60' from DER, 190' left of centerline, up to 1715' MSL.

Fence 129' from DER, 105' right of centerline, 4' AGL/1709' MSL.

Building 164' from DER, 495' right of centerline, 13' AGL/1721' MSL.

Tree 198' from DER, 296' left of centerline, 1719' MSL.

Tree 222' from DER, 485' left of centerline, 1721' MSL.

Trees and vehicles on road beginning 250' from DER, 32' left of centerline, up to 1771' MSL.

Trees, vegetation, poles, tower, and vehicles on road beginning 311' from DER, 14' right of centerline, up to 1799' MSL.

Trees and poles beginning 544' from DER, 1' left of centerline, up to 1785' MSL.

Trees, poles, buildings, towers, antenna, and fence beginning 656' from DER, 3' right of centerline, up to 1801' MSL.

Trees and pole beginning 933' from DER, 43' left of centerline, up to 1790' MSL.

Trees, poles, and stack beginning 1006' from DER, 7' left of centerline, up to 1800' MSL.

Trees and buildings beginning 1538' from DER, 0' left of centerline, up to 1801' MSL.

Trees beginning 1584' from DER, 0' right of centerline, up to 1812' MSL.

Trees beginning 2102' from DER, 70' left of centerline, up to 1803' MSL.

Trees beginning 2195' from DER, 55' left of centerline, up to 1805' MSL.

Trees beginning 2317' from DER, 9' left of centerline, up to 1812' MSL.

Tree 5499' from DER, 1769' right of centerline, 1847' MSL.

Tree 5596' from DER, 1779' right of centerline, 1852' MSL.

Trees beginning 5620' from DER, 1552' right of centerline, up to 1867' MSL.

Trees beginning 5813' from DER, 1528' right of centerline, up to 1877' MSL.

Trees beginning 5848' from DER, 1372' right of centerline, up to 1879' MSL.

Trees beginning 5967' from DER, 747' right of centerline, up to 1890' MSL.

Tree 1.1 NM from DER, 720' right of centerline, 1881' MSL.

LAWRENCEVILLE, IL

LAWRENCEVILLE-VINCENNES INTL (LWV)

TAKEOFF MINIMUMS AND (OBSTACLE) DEPARTURE PROCEDURES

ORIG-A 19JUL18 (18200) (FAA)

TAKEOFF OBSTACLE NOTES:

Rwy 9, ag equipment, 435' from DER, 479' right of centerline, 23' AGL/452' MSL.

Rwy 18, ag equipment beginning 274' from DER, 299' right of centerline, up to 448' MSL.

Ag equipment 585' from DER, 473' left of centerline, 445' MSL.

Ag equipment beginning 684' from DER, 362' left of centerline, up to 446' MSL.

Rwy 27, vehicle on road 331' from DER, 453' left of centerline, 439' MSL.

Ag equipment 597' from DER, 474' right of centerline, 22' AGL/443' MSL.

Rwy 36, tree 3454' from DER, 1063' right of centerline, 100' AGL/539' MSL.

LINCOLN, IL

LOGAN COUNTY (AAA)

TAKEOFF MINIMUMS AND (OBSTACLE) DEPARTURE PROCEDURES

AMDT 1A 31MAR16 (16091) (FAA)

TAKEOFF MINIMUMS:

Rwy 14, 32, NA-Environmental.

Rwy 21, 300-½ or std. with a min. climb of 341' per NM to 800.

TAKEOFF OBSTACLE NOTES:

Rwy 3, road/vehicles beginning 210' from DER, 296' right of centerline, up to 15' AGL/607' MSL.

Trees beginning 783' from DER, 353' left of centerline, up to 100' AGL/664' MSL.

Trees 2733' from DER, 390' left of centerline, up to 100' AGL/676' MSL.

Rwy 21, NAVAID 9' from DER, 111' right of centerline, 3' AGL/594' MSL.

Trees beginning 377' from DER, 546' right of centerline, up to 100' AGL/621' MSL.

Trees beginning 1773' from DER, 155' right of centerline, up to 100' AGL/669' MSL.

Multiple towers beginning 3190' from DER, 579' right of centerline, up to 101' AGL/689' MSL.

Tower 4139' from DER, 158' left of centerline, 126' AGL/715' MSL.

TAKEOFF MINIMUMS, (OBSTACLE) DEPARTURE PROCEDURES, AND DIVERSE VECTOR AREA (RADAR VECTORS)

23278

EC-3

TAKEOFF MINIMUMS, (OBSTACLE) DEPARTURE PROCEDURES, AND DIVERSE VECTOR AREA (RADAR VECTORS)

23278

LITCHFIELD, IL

LITCHFIELD MUNI (3LF)

TAKEOFF MINIMUMS AND (OBSTACLE) DEPARTURE PROCEDURES

AMDT 3A 11OCT18 (18284) (FAA)

TAKEOFF OBSTACLE NOTES:

Rwy 9, general utility poles 83' from DER, 261' left of centerline, 6' AGL/695' MSL.
Transmission line, pole beginning 146' from DER, 476' left of centerline, up to 31' AGL/720' MSL.
Vehicle on traverse way 178' from DER, 422' right of centerline, 701' MSL.
Vehicle on traverse way 269' from DER, 382' right of centerline, 702' MSL.
Building 285' from DER, 566' right of centerline, 33' AGL/720' MSL.
Transmission line, pole, building beginning 318' from DER, 476' left of centerline, up to 31' AGL/721' MSL.
Tree, vehicle on traverse way, pole, transmission line beginning 327' from DER, 12' right of centerline, up to 730' MSL.
Transmission line, pole, vehicle on traverse way beginning 499' from DER, 68' left of centerline, up to 33' AGL/725' MSL.
Transmission line, pole, tree beginning 745' from DER, 72' left of centerline, up to 38' AGL/729' MSL.
Tower, tree, building, tank beginning 1059' from DER, 66' left of centerline, up to 132' AGL/822' MSL.
Trees, beginning 1688' from DER, 431' right of centerline, up to 741' MSL.
Trees beginning 2538' from DER, 582' right of centerline, up to 82' AGL/758' MSL.
Rwy 18, tree 494' from DER, 610' left of centerline, 746' MSL.
Rwy 27, REIL 10' from DER, 115' left of centerline, up to 2' AGL/683' MSL.
Vehicle on traverse way beginning 13' from DER, 483' right of centerline, up to 15' AGL/693' MSL.
Vehicle on traverse way 192' from DER, 132' left of centerline, 692' MSL.
Vehicle on traverse way beginning 303' from DER, 127' right of centerline, up to 15' AGL/694' MSL.
Vehicle on traverse way beginning 344' from DER, 77' right of centerline, up to 17' AGL/698' MSL.
Trees beginning 689' from DER, 441' right of centerline, up to 717' MSL.
Tree 777' from DER, 445' left of centerline, 702' MSL.
Transmission line, pole, tree beginning 900' from DER, 436' right of centerline, up to 38' AGL/718' MSL.
Rwy 36, tower, pole, tree beginning 2186' from DER, 75' left of centerline, up to 56' AGL/748' MSL.
Tree, sign beginning 2272' from DER, 116' right of centerline, up to 752' MSL.
Transmission line 2682' from DER, 71' right of centerline, 61' AGL/753' MSL.
Tank 2735' from DER, 1121' left of centerline, 71' AGL/763' MSL.

LONE ROCK, WI

TRI COUNTY RGNL (LNR)

TAKEOFF MINIMUMS AND (OBSTACLE) DEPARTURE PROCEDURES

AMDT 4 03JUL08 (08185) (FAA)

TAKEOFF MINIMUMS:

Rwys 9, 27, 600-1¼, or 1000-2½ for climb in visual conditions.**Rwys 18, 36**, NA-Environmental.

DEPARTURE PROCEDURE:

Rwys 9, 27, for climb in visual conditions: cross Tri-County Rgnl Airport at or above 1600 before proceeding on course.

TAKEOFF OBSTACLE NOTES:

Rwy 9, terrain and trees beginning 23' from DER, 238' left of centerline, up to 100' AGL/1129' MSL.
Road beginning 244' from DER, 330' left of centerline, up to 17' AGL/733' MSL.
Terrain and trees beginning 18' from DER, 235' right of centerline, up to 100' AGL/722' MSL.
Rwy 27, building 764' from DER, 386' left of centerline, up to 25' AGL/744' MSL.
Tree 1381' from DER, 590' left of centerline, up to 70' AGL/785' MSL.
Road beginning 245' from DER, on centerline, up to 12' AGL/731' MSL.
Antennas and poles beginning 920' from DER, 372' right of centerline, up to 33' AGL/752' MSL.
Trees and terrain beginning 2 NM from DER, 2658' right of centerline, up to 100' AGL/1199' MSL.

MACOMB, IL

MACOMB MUNI (MQB)

TAKEOFF MINIMUMS AND (OBSTACLE) DEPARTURE PROCEDURES

AMDT 1 24AUG89 (89236) (FAA)

DEPARTURE PROCEDURE:

Rwy 18, climb runway heading to 1700 before turning right.**Rwy 27**, climb runway heading to 1700 before turning left.

MADISON, WI

BLACKHAWK AIRFIELD (87Y)

TAKEOFF MINIMUMS AND (OBSTACLE) DEPARTURE PROCEDURES

AMDT 2A 11AUG22 (22223) (FAA)

TAKEOFF MINIMUMS:

Rwy 4, 300-2 or std. w/min. climb of 300' per NM to 1500.**Rwy 22**, 300-2 or std. w/min. climb of 479' per NM to 1300.**Rwy 27**, 300-2¼ or std. w/min. climb of 260' per NM to 1400.

DEPARTURE PROCEDURE:

Rwy 4, climb heading 043° to 1500 before turning left.

TAKEOFF OBSTACLE NOTES:

Rwy 4, trees beginning 35' from DER, left and right of centerline, up to 35' AGL/934' MSL.
Vehicle on road beginning 785' from DER, left and right of centerline, up to 17' AGL/926' MSL.
Trees beginning 1.6 NM from DER, left and right of centerline, up to 100' AGL/1069' MSL.
CON'T

TAKEOFF MINIMUMS, (OBSTACLE) DEPARTURE PROCEDURES, AND DIVERSE VECTOR AREA (RADAR VECTORS)

23278

EC-3

TAKEOFF MINIMUMS, (OBSTACLE) DEPARTURE PROCEDURES, AND DIVERSE VECTOR AREA (RADAR VECTORS)

23278

MADISON, WI (CON'T)

BLACKHAWK AIRFIELD (87Y) (CON'T)

- Rwy 9**, trees beginning 141' from DER, 249' left of centerline, up to 35' AGL/974' MSL.
Vehicle on road beginning 265' from DER, left and right of centerline, up to 15' AGL/944' MSL.
Trees and buildings beginning 1071' from DER, 612' right of centerline, up to 30' AGL/939' MSL.
Trees beginning 1337' from DER, left and right of centerline, up to 100' AGL/999' MSL.
Trees and buildings beginning 1456' from DER, 729' left of centerline, up to 100' AGL/1009' MSL.
Rwy 22, trees beginning 35' from DER, left and right of centerline, up to 35' AGL/944' MSL.
Houses beginning 1085' from DER, left and right of centerline, up to 30' AGL/1019' MSL.
Vehicles on road beginning 1087' from DER, left and right of centerline, up to 15' AGL/974' MSL.
Water tower 3995' from DER, 792' left of centerline, 81' AGL/1089' MSL.
Rwy 27, tower 5474' from DER, 1145' right of centerline, 55' AGL/1065' MSL.

DANE COUNTY RGNL/TRUAX FLD (MSN)

TAKEOFF MINIMUMS AND (OBSTACLE) DEPARTURE PROCEDURES

AMDT 8A 04FEB16 (21336) (FAA)

TAKEOFF MINIMUMS:

- Rwy 3**, 200-1½ or std. w/min. climb of 212' per NM to 1200.

DEPARTURE PROCEDURE:

- Rwy 18**, (southwest departures 200° CW 260°) climb on heading 179° to 3200 before proceeding on course.
Rwy 21, (southwest departures 200° CW 260°) climb on heading 206° to 3200 before proceeding on course.

TAKEOFF OBSTACLE NOTES:

- Rwy 3**, tower 7137' from DER, 2392' left of centerline, 132' AGL/1082' MSL.
Trees beginning 4368' from DER, 1526' left of centerline, up to 100' AGL/1082' MSL.
Rwy 14, trees and poles beginning 936' from DER, left and right of centerline, up to 100' AGL/986' MSL.
Antenna on building 3747' from DER, 1283' left of centerline, 57' AGL/976' MSL.
Vehicle on road 134' from DER, left to right of centerline, up to 17' AGL/874' MSL.
Rwy 18, trees beginning 287' from DER, left and right of centerline, up to 100' AGL/941' MSL.
Rwy 21, trees beginning 1557' from DER, 383' right of centerline, up to 100' AGL/972' MSL.
Sign 29' from DER, 118' left of centerline, 6' AGL/862' MSL.
Glidepole antenna 1144' from DER, 140' left of centerline, 39' AGL/898' MSL.
Rwy 32, trees beginning 1810' from DER, left and right of centerline, up to 100' AGL/948' MSL.
Railroad 672' from DER, left to right of centerline, 23' AGL/882' MSL.
Rwy 36, trees and pole beginning 1325' from DER, left and right of centerline, up to 100' AGL/1012' MSL.
Rapidly rising terrain 1467' from DER, 678' right of centerline, up to 947' MSL.
Vehicle on road 1154' from DER, left to right of centerline, up to 17' AGL/908' MSL.

MANITOWISH WATERS, WI

MANITOWISH WATERS (D25)

TAKEOFF MINIMUMS AND (OBSTACLE) DEPARTURE PROCEDURES

ORIG 03JUN10 (10154) (FAA)

TAKEOFF MINIMUMS:

- Rwys 4, 22**, NA-Environment.

TAKEOFF OBSTACLE NOTES:

- Rwy 14**, trees beginning 93' from DER, 225' right of centerline, up to 100' AGL/1709' MSL.
Trees beginning 279' from DER, 441' left of centerline, up to 100' AGL/1709' MSL.
Rwy 32, trees beginning 70' from DER, 343' left of centerline, up to 100' AGL/1714' MSL.
Trees beginning 151' from DER, 362' right of centerline, up to 100' AGL/1714' MSL.
Road 617' from DER, 44' right of centerline, 15' AGL/1634' MSL.

MANITOWOC, WI

MANITOWOC COUNTY (MTW)

TAKEOFF MINIMUMS AND (OBSTACLE) DEPARTURE PROCEDURES

AMDT 4 12MAR09 (09071) (FAA)

TAKEOFF MINIMUMS:

- Rwy 17**, 300-1½ or std. with a min. climb of 254' per NM to 1000.

DEPARTURE PROCEDURE:

- Rwy 7**, climb heading 072° to 1200 before proceeding on course.
Rwy 25, climb heading 252° to 1200 before proceeding on course.

TAKEOFF OBSTACLE NOTES:

- Rwy 7**, tree 520' from DER, 279' left of centerline, 27' AGL/666' MSL.
Rwy 17, stack 1.24 NM from DER, 1915' left of centerline, 310' AGL/893' MSL.
Trees beginning 23' from DER, 16' left of centerline, up to 94' AGL/743' MSL.
Trees beginning 1802' from DER, 76' right of centerline, up to 98' AGL/747' MSL.
Flagpole 1234' from DER, 512' right of centerline, 36' AGL/695' MSL.
Antenna 989' from DER, 511' right of centerline, 39' AGL/688' MSL.
Rwy 25, tree 734' from DER, 321' right of centerline, 48' AGL/697' MSL.
Tree 1870' from DER, 223' left of centerline, 63' AGL/722' MSL.
Train on railroad, 744' from DER, on centerline, 23' AGL/676' MSL.
Rwy 35, trees beginning 167' from DER, 477' right of centerline, up to 66' AGL/710' MSL.
Tree 2012' from DER, 863' left of centerline, 67' AGL/716' MSL.

TAKEOFF MINIMUMS, (OBSTACLE) DEPARTURE PROCEDURES, AND DIVERSE VECTOR AREA (RADAR VECTORS)

23278

EC-3

TAKEOFF MINIMUMS, (OBSTACLE) DEPARTURE PROCEDURES, AND DIVERSE VECTOR AREA (RADAR VECTORS)

23278

MARION, IL

VETERANS AIRPORT OF SOUTHERN ILLINOIS (MWA)
TAKEOFF MINIMUMS AND (OBSTACLE) DEPARTURE PROCEDURES
AMDT 1 17AUG17 (17229) (FAA)

TAKEOFF MINIMUMS:

Rwy 11, 600-3 or std. w/min. climb of 235' per NM to 1200.

DEPARTURE PROCEDURE:

Rwy 11, Climb via heading 107° to 1100 before turning left.

TAKEOFF OBSTACLE NOTES:

Rwy 2, trees beginning 119' from DER, 265' left of centerline, up to 106' AGL/543' MSL.

Rwy 11, poles beginning 630' from DER, 496' right of centerline, up to 75' AGL/518' MSL.

Tree 1298' from DER, 594' right of centerline, 81' AGL/528' MSL.

Tank 5154' from DER, 800' right of centerline, 164' AGL/601' MSL.

Tower 3.16 NM from DER, 1.32 NM left of centerline, 490' AGL/980' MSL.

Rwy 20, trees beginning 1538' from DER, 823' right of centerline, up to 68' AGL/521' MSL.

Rwy 29, wind sock 341' from DER, 291' left of centerline, 11' AGL/461' MSL.

Trees beginning 559' from DER, 360' right of centerline, up to 77' AGL/534' MSL.

Theater screen 1347' from DER, 634' right of centerline, 77' AGL/530' MSL.

MARSHFIELD, WI

MARSHFIELD MUNI (MFI)
TAKEOFF MINIMUMS AND (OBSTACLE) DEPARTURE PROCEDURES
ORIG 28SEP06 (06271) (FAA)

TAKEOFF OBSTACLE NOTES:

Rwy 34, multiple trees beginning 1412' from DER, 532' left of centerline, up to 60' AGL/1359' MSL.

MATTOON/CHARLESTON, IL

COLES COUNTY MEML (MTO)
TAKEOFF MINIMUMS AND (OBSTACLE) DEPARTURE PROCEDURES
AMDT 4 17DEC09 (21112) (FAA)

TAKEOFF OBSTACLE NOTES:

Rwy 11, trees beginning 1842' from DER, 869' left of centerline, up to 100' AGL/803' MSL.

MEDFORD, WI

TAYLOR COUNTY (MDZ)
TAKEOFF MINIMUMS AND (OBSTACLE) DEPARTURE PROCEDURES
AMDT 3 07MAR13 (13066) (FAA)

TAKEOFF OBSTACLE NOTES:

Rwy 9, trees beginning 1123' from DER, 561' left of centerline, up to 61' AGL/1540' MSL.

Trees beginning 2555' from DER, 592' right of centerline, up to 85' AGL/1544' MSL.

Rwy 16, trees beginning 7' from DER, 248' left of centerline, up to 75' AGL/1524' MSL.

Vehicle on road beginning 33' from DER, 8' left of centerline, up to 15' AGL/1466' MSL.

Vehicle on road beginning 27' from DER, 93' right of centerline, up to 15' AGL/1462' MSL.

Rwy 27, pole 112' from DER, 498' right of centerline, 13' AGL/1482' MSL.

Windsock 389' from DER, 270' right of centerline, 18' AGL/1487' MSL.

Antenna 598' from DER, 501' right of centerline, 11' AGL/1480' MSL.

Trees beginning 2049' from DER, 627' left of centerline, up to 75' AGL/1525' MSL.

Tower 3741' from DER, 1111' left of centerline, 150' AGL/1580' MSL.

Rwy 34, terrain beginning 37' from DER, 482' right of centerline, 1461' MSL.

Trees beginning 370' from DER, 187' right of centerline, up to 41' AGL/1510' MSL.

Poles beginning 489' from DER, 310' right of centerline, up to 26' AGL/1488' MSL.

MENOMONIE, WI

MENOMONIE MUNI/SCORE FLD (LUM)
TAKEOFF MINIMUMS AND (OBSTACLE) DEPARTURE PROCEDURES
AMDT 2 20JUN19 (21336) (FAA)

TAKEOFF MINIMUMS:

Rwy 18, 500-2½ or std. w/min. climb of 601' per NM to 1700.

DEPARTURE PROCEDURE:

Rwy 18, climb heading 176° to 1600 before turning right.

Rwy 36, climb heading 356° to 1800 before turning left.

TAKEOFF OBSTACLE NOTES:

Rwy 9, buildings beginning 116' from DER, 347' right of centerline, up to 27' AGL/915' MSL.

Building 563' from DER, 545' right of centerline, 52' AGL/939' MSL.

Rwy 18, trees beginning 7' from DER, 329' right of centerline, up to 100' AGL/999' MSL.

Tree 922' from DER, 175' left of centerline, 100' AGL/999' MSL.

Tree 2264' from DER, 497' right of centerline, 100' AGL/1019' MSL.

Tree 2484' from DER, 501' right of centerline, 100' AGL/1059' MSL.

Tree 2621' from DER, 514' right of centerline, 100' AGL/1079' MSL.

Tree 2743' from DER, 586' right of centerline, 100' AGL/1099' MSL.

Trees beginning 3636' from DER, 126' right of centerline, up to 100' AGL/1119' MSL.

CON'T

TAKEOFF MINIMUMS, (OBSTACLE) DEPARTURE PROCEDURES, AND DIVERSE VECTOR AREA (RADAR VECTORS)

23278

EC-3

TAKEOFF MINIMUMS, (OBSTACLE) DEPARTURE PROCEDURES, AND DIVERSE VECTOR AREA (RADAR VECTORS)

23278

MENOMONIE, WI (CON'T)

MENOMONIE MUNI/SCORE FLD (LUM) (CON'T)

- Rwy 18 (CON'T)**, tree 4388' from DER, 1090' left of centerline, 100' AGL/1019' MSL.
Tree 1.6 NM from DER, 2577' right of centerline, 100' AGL/1239' MSL.
Tower and trees beginning 1.6 NM from DER, 728' right of centerline, up to 250' AGL/1370' MSL.
Tree 1.6 NM from DER, 2278' left of centerline, 100' AGL/1219' MSL.
Tree 2 NM from DER, 122' right of centerline, 100' AGL/1239' MSL.
Rwy 27, trees and pole beginning 434' from DER, 545' right of centerline, up to 943' MSL.
Tree 2620' from DER, 688' left of centerline, 969' MSL.
Stack and trees beginning 2667' from DER, 579' left of centerline, up to 93' AGL/987' MSL.
Rwy 36, trees and buildings beginning 207' from DER, 62' left of centerline, up to 100' AGL/999' MSL.
Buildings and vehicles on road beginning 409' from DER, 290' right of centerline, up to 40' AGL/959' MSL.
Tree 929' from DER, 383' right of centerline, 100' AGL/1019' MSL.

MERRILL, WI

MERRILL MUNI (RRL)

TAKEOFF MINIMUMS AND (OBSTACLE) DEPARTURE PROCEDURES

ORIG 30AUG07 (07242) (FAA)

TAKEOFF OBSTACLE NOTES:

- Rwy 7**, bush 55' from DER, 468' left of centerline, 5' AGL/1311' MSL.
Pole 392' from DER, 512' right of centerline, 23' AGL/1329' MSL.
Building 358' from DER, 451' right of centerline, 21' AGL/1327' MSL.
Multiple trees beginning 905' from DER, from 727' right to 552' left of centerline, up to 91' AGL/1400' MSL.
Multiple trees beginning 2597' from DER, from 22' right to 86' left of centerline, up to 82' AGL/1401' MSL.
Rwy 16, multiple trees beginning 1587' from DER, on centerline, up to 100' AGL/1439' MSL.
Rwy 25, bush 132' from DER, 494' right of centerline, 13' AGL/1331' MSL.
Pole 1240' from DER, 778' left of centerline, 37' AGL/1356' MSL.
Multiple trees beginning 1085' from DER, from 554' right to 359' left of centerline, up to 69' AGL/1388' MSL.
Rwy 34, multiple trees beginning 49' from DER, from 33' right to 139' left of centerline, up to 100' AGL/1439' MSL.

MIDDLETON, WI

MIDDLETON MUNI/MOREY FLD (C29)

TAKEOFF MINIMUMS AND (OBSTACLE) DEPARTURE PROCEDURES

AMDT 2A 02DEC21 (21336) (FAA)

TAKEOFF MINIMUMS:

- Rwys 1, 19**, NA-Turf.
Rwy 10, 300-1½ or std. w/min. climb of 233' per NM to 1200, or alternatively, with standard takeoff minimums and a normal 200' per NM climb gradient, takeoff must occur no later than 1900' prior to DER.
Rwy 28, 300-2 or std. w/min. climb of 293' per NM to 1400.

DEPARTURE PROCEDURE:

- Rwy 10**, climb on heading 101° to 2600 before turning right.
Rwy 28, climb on heading 281° to 2600 before turning left.

TAKEOFF OBSTACLE NOTES:

- Rwy 10**, building 72' from DER, 421' right of centerline, 25' AGL/951' MSL.
Vegetation 128' from DER, 316' left of centerline, 933' MSL.
Pole 583' from DER, 516' right of centerline, 32' AGL/953' MSL.
Pole 874' from DER, 461' right of centerline, 33' AGL/954' MSL.
Terrain 1041' from DER, 755' left of centerline, 972' MSL.
Poles beginning 1148' from DER, 523' left of centerline, up to 30' AGL/973' MSL.
Tree 1168' from DER, 591' right of centerline, 991' MSL.
Building, trees beginning 1276' from DER, 199' left of centerline, up to 30' AGL/975' MSL.
Trees, transmission lines, poles beginning 1299' from DER, 225' right of centerline, up to 81' AGL/1002' MSL.
Poles, transmission lines beginning 2823' from DER, 26' right of centerline, up to 1003' MSL.
Water tower 1 NM from DER, 1833' left of centerline, 94' AGL/1087' MSL.
Tank 1 NM from DER, 1821' left of centerline, 113' AGL/1108' MSL.
Rwy 28, vegetation 36' from DER, 173' left of centerline, 930' MSL.
Vegetation 198' from DER, 346' right of centerline, 938' MSL.
Tree 524' from DER, 470' left of centerline, 944' MSL.
Trees beginning 843' from DER, 647' left of centerline, up to 52' AGL/985' MSL.
Trees beginning 1199' from DER, 574' left of centerline, up to 999' MSL.
Trees beginning 2160' from DER, 425' left of centerline, up to 1023' MSL.
Tree, building beginning 2416' from DER, 35' left of centerline, up to 1026' MSL.
Tree 2626' from DER, 17' right of centerline, 1008' MSL.
Trees beginning 2633' from DER, 109' left of centerline, up to 1031' MSL.
Tree 2708' from DER, 1' right of centerline, 1019' MSL.
Tree 3081' from DER, 134' right of centerline, 1022' MSL.
Trees beginning 3088' from DER, 135' right of centerline, up to 1037' MSL.
Tree 4291' from DER, 481' right of centerline, 1038' MSL.
Tree 5015' from DER, 70' right of centerline, 1071' MSL.
Tree 5145' from DER, 74' left of centerline, 1095' MSL.
Trees beginning 5293' from DER, 24' right of centerline, up to 1109' MSL.
Trees beginning 5307' from DER, 112' left of centerline, up to 1098' MSL.
Tree, building beginning 5458' from DER, 7' left of centerline, up to 1105' MSL.

CON'T

TAKEOFF MINIMUMS, (OBSTACLE) DEPARTURE PROCEDURES, AND DIVERSE VECTOR AREA (RADAR VECTORS)

23278

EC-3

TAKEOFF MINIMUMS, (OBSTACLE) DEPARTURE PROCEDURES, AND DIVERSE VECTOR AREA (RADAR VECTORS)

23278

MIDDLETON, WI (CON'T)

MIDDLETON MUNI/MOREY FLD (C29) (CON'T)

Rwy 28 (CON'T), tree 1 NM from DER, 302' left of centerline, 1107' MSL.
 Tree 1 NM from DER, 420' left of centerline, 1121' MSL.
 Tree 1 NM from DER, 652' left of centerline, 1124' MSL.
 Tree 1 NM from DER, 664' left of centerline, 1127' MSL.
 Tree 1.3 NM from DER, 2609' left of centerline, 63' AGL/1139' MSL.
 Transmission line beginning 1.5 NM from DER, 214' left of centerline, up to 131' AGL/1206' MSL.
 Transmission line 1.5 NM from DER, 579' right of centerline, 123' AGL/1202' MSL.
 Transmission line beginning 1.6 NM from DER, 1294' right of centerline, up to 141' AGL/1217' MSL.

MILWAUKEE, WI

GENERAL MITCHELL INTL (MKE)

TAKEOFF MINIMUMS AND (OBSTACLE) DEPARTURE PROCEDURES

AMDT 9 05OCT23 (23278) (FAA)

TAKEOFF MINIMUMS:

Rwy 7R, 300-1½ or std w/min climb of 293'/NM to 1100.

Rwy 31, 300-1¾ or std w/min climb of 255'/NM to 1000.

TAKEOFF OBSTACLE NOTES:

Rwy 1L, fence 147' from DER, 391' left of centerline, 8' AGL/678' MSL.
 Light poles 410' from DER, 1' right of centerline, 13' AGL/685' MSL.
 Vehicle on road 485' from DER, left and right of centerline, 686' MSL.
 Vehicle on road 494' from DER, left and right of centerline, 687' MSL.
 Vehicle on road beginning 514' from DER, left and right of centerline, up to 687' MSL.
 Pole 575' from DER, 594' left of centerline, 17' AGL/689' MSL.
 Light poles 625' from DER, 1' right of centerline, 21' AGL/692' MSL.
 Light poles 824' from DER, on centerline, 20' AGL/694' MSL.
 Pole, tree, light poles, utility building beginning 1859' from DER, 1' right of centerline, up to 21' AGL/734' MSL.
 Light poles 1928' from DER, 8' left of centerline, 21' AGL/727' MSL.
 Tree 2011' from DER, 966' right of centerline, 738' MSL.
 Tree, poles beginning 2154' from DER, 835' right of centerline, up to 751' MSL.
 Poles beginning 2354' from DER, 682' right of centerline, up to 31' AGL/754' MSL.
 Trees beginning 2384' from DER, 920' left of centerline, up to 785' MSL.
 Trees beginning 2772' from DER, 431' left of centerline, up to 790' MSL.
 Tree 3724' from DER, 84' right of centerline, 780' MSL.
 Trees beginning 3777' from DER, 101' right of centerline, up to 782' MSL.
Rwy 1R, light poles 10' from DER, 54' right of centerline, 2' AGL/671' MSL.
 Light poles 10' from DER, 55' left of centerline, 2' AGL/671' MSL.
 Sign 75' from DER, 249' left of centerline, 5' AGL/672' MSL.
 Antenna 579' from DER, 601' left of centerline, 51' AGL/718' MSL.
 Tower 581' from DER, 600' left of centerline, 53' AGL/719' MSL.
 Tree 3596' from DER, 729' right of centerline, 761' MSL.
 Trees beginning 3724' from DER, 600' right of centerline, up to 778' MSL.
 Trees beginning 4101' from DER, 213' right of centerline, up to 794' MSL.
 Trees beginning 4499' from DER, 979' right of centerline, up to 795' MSL.
Rwy 7L, light poles 35' from DER, 88' right of centerline, 3' AGL/676' MSL.
 Building 320' from DER, 455' right of centerline, 25' AGL/696' MSL.
 Building 1262' from DER, 735' left of centerline, 21' AGL/721' MSL.
 Pole 1324' from DER, 453' left of centerline, 31' AGL/733' MSL.
 Poles beginning 1341' from DER, 58' right of centerline, up to 38' AGL/711' MSL.
 Tree, poles beginning 1407' from DER, 47' left of centerline, up to 739' MSL.
 Vehicle on road 1441' from DER, 292' right of centerline, 713' MSL.
 Tree, vehicle on road beginning 1466' from DER, 112' right of centerline, up to 718' MSL.
 Tree, poles, vehicle on road beginning 1472' from DER, 214' left of centerline, up to 746' MSL.
 Trees, poles, vehicles on road beginning 1538' from DER, 49' left of centerline, up to 754' MSL.
 Pole 1583' from DER, 223' right of centerline, 40' AGL/732' MSL.
 Pole 1664' from DER, 51' right of centerline, 40' AGL/734' MSL.
 Trees, poles, vehicle on road, signs, buildings beginning 1882' from DER, 94' left of centerline, up to 759' MSL.
 Trees, poles, building, signs beginning 2195' from DER, 14' left of centerline, up to 771' MSL.
 Pole 2256' from DER, 221' right of centerline, 35' AGL/739' MSL.
 Poles, trees, building beginning 2297' from DER, 10' right of centerline, up to 42' AGL/752' MSL.
 Trees, poles beginning 2591' from DER, 42' left of centerline, up to 775' MSL.
 Poles, tree beginning 2885' from DER, 38' right of centerline, up to 44' AGL/757' MSL.
 Trees, pole, sign beginning 2891' from DER, 13' left of centerline, up to 777' MSL.
 Pole 3166' from DER, 361' right of centerline, 66' AGL/772' MSL.
 Trees beginning 3685' from DER, 961' left of centerline, up to 781' MSL.
 Trees beginning 3813' from DER, 97' right of centerline, up to 785' MSL.
Rwy 7R, sign 34' from DER, 286' left of centerline, 3' AGL/671' MSL.
 Pole 700' from DER, 538' right of centerline, 39' AGL/707' MSL.
 Pole 706' from DER, 543' right of centerline, 41' AGL/709' MSL.
 Vehicles on road, trees, poles beginning 753' from DER, 203' right of centerline, up to 711' MSL.
 Railroad, pole, trees beginning 922' from DER, 64' right of centerline, up to 712' MSL.
 Pole 1051' from DER, 199' left of centerline, 39' AGL/708' MSL.
 Railroad, trees, poles beginning 1086' from DER, 77' left of centerline, up to 712' MSL.

CON'T

TAKEOFF MINIMUMS, (OBSTACLE) DEPARTURE PROCEDURES, AND DIVERSE VECTOR AREA (RADAR VECTORS)

23278

TAKEOFF MINIMUMS, (OBSTACLE) DEPARTURE PROCEDURES, AND DIVERSE VECTOR AREA (RADAR VECTORS)

23278

MILWAUKEE, WI (CON'T)

GENERAL MITCHELL INTL (MKE) (CON'T)

Rwy 7R (CON'T), trees beginning 1415' from DER, 685' left of centerline, up to 732' MSL.

Trees beginning 1810' from DER, 895' right of centerline, up to 746' MSL.

Tree 2241' from DER, 870' right of centerline, 752' MSL.

Tree 2300' from DER, 337' left of centerline, 735' MSL.

Trees beginning 2310' from DER, 327' right of centerline, up to 755' MSL.

Tree 2347' from DER, 815' right of centerline, 759' MSL.

Trees beginning 2364' from DER, 224' left of centerline, up to 743' MSL.

Trees beginning 2389' from DER, 177' right of centerline, up to 763' MSL.

Stack 1.1 NM from DER, 2098' right of centerline, 217' AGL/930' MSL.

Stack 1.2 NM from DER, 1166' left of centerline, 180' AGL/891' MSL.

Rwy 13, sign 49' from DER, 471' right of centerline, 4' AGL/671' MSL.

Sign 81' from DER, 405' left of centerline, 10' AGL/678' MSL.

Tree 701' from DER, 581' left of centerline, 697' MSL.

Vehicles on road, poles, trees, transmission line, vegetation beginning 703' from DER, 23' left of centerline, up to 712' MSL.

Tree, pole beginning 1136' from DER, 56' right of centerline, up to 707' MSL.

Pole 1186' from DER, 144' right of centerline, 41' AGL/709' MSL.

Railroad, pole, trees beginning 1262' from DER, 134' right of centerline, up to 711' MSL.

Antenna, tree beginning 1371' from DER, 43' right of centerline, up to 59' AGL/730' MSL.

Tree 1690' from DER, 119' left of centerline, 717' MSL.

Tree 1844' from DER, 306' left of centerline, 718' MSL.

Trees beginning 1905' from DER, 166' left of centerline, up to 721' MSL.

Trees beginning 2034' from DER, 137' left of centerline, up to 746' MSL.

Trees beginning 2224' from DER, 57' left of centerline, up to 752' MSL.

Tree 2333' from DER, 255' right of centerline, 737' MSL.

Tree 2397' from DER, 42' right of centerline, 739' MSL.

Trees beginning 2453' from DER, 164' right of centerline, up to 749' MSL.

Rwy 19L, tower, antenna beginning 1837' from DER, 558' right of centerline, up to 71' AGL/749' MSL.

Trees beginning 1869' from DER, 795' left of centerline, up to 753' MSL.

Trees beginning 2181' from DER, 739' left of centerline, up to 761' MSL.

Rwy 19R, trees beginning 2392' from DER, 1035' right of centerline, up to 821' MSL.

Rwy 25L, lighting 10' from DER, 4' left of centerline, 1' AGL/730' MSL.

Building 2790' from DER, 1223' right of centerline, 55' AGL/812' MSL.

Rwy 25R, light poles 32' from DER, 89' left of centerline, 3' AGL/674' MSL.

Light poles 33' from DER, 88' right of centerline, 3' AGL/673' MSL.

Fence 183' from DER, 386' left of centerline, 12' AGL/684' MSL.

Building 627' from DER, 363' right of centerline, 33' AGL/704' MSL.

Poles beginning 1139' from DER, 127' right of centerline, up to 31' AGL/706' MSL.

Pole 1274' from DER, 141' left of centerline, 31' AGL/706' MSL.

Tree 1302' from DER, 222' left of centerline, 715' MSL.

Trees, signs beginning 1302' from DER, 100' left of centerline, up to 717' MSL.

Trees beginning 1314' from DER, 91' right of centerline, up to 711' MSL.

Sign, pole beginning 1398' from DER, 137' left of centerline, up to 68' AGL/748' MSL.

Pole 1608' from DER, 301' right of centerline, 43' AGL/720' MSL.

Tree 4188' from DER, 169' right of centerline, 777' MSL.

Rwy 31, light poles 13' from DER, 40' left of centerline, 1' AGL/672' MSL.

Poles, fence, vehicle on road beginning 30' from DER, 162' right of centerline, up to 31' AGL/707' MSL.

Tree, fence, poles, vehicle on road beginning 326' from DER, 6' right of centerline, up to 710' MSL.

Fence 473' from DER, 3' left of centerline, 12' AGL/683' MSL.

Poles beginning 583' from DER, 27' left of centerline, up to 31' AGL/703' MSL.

Trees beginning 976' from DER, 435' right of centerline, up to 753' MSL.

Tree 1334' from DER, 579' right of centerline, 755' MSL.

Trees, pole beginning 1352' from DER, 272' right of centerline, up to 759' MSL.

Trees, building, poles beginning 1462' from DER, 199' right of centerline, up to 765' MSL.

Tree 1589' from DER, 280' left of centerline, 711' MSL.

Tree 1634' from DER, 196' left of centerline, 712' MSL.

Tree 1774' from DER, 163' left of centerline, 716' MSL.

Trees, poles beginning 1797' from DER, 60' right of centerline, up to 766' MSL.

Tree 1921' from DER, 145' left of centerline, 725' MSL.

Tree 2131' from DER, 60' left of centerline, 728' MSL.

Tree 2170' from DER, 17' left of centerline, 730' MSL.

Tree 2381' from DER, 131' left of centerline, 734' MSL.

Trees, poles, transmission line, building beginning 2386' from DER, 46' right of centerline, up to 768' MSL.

Trees beginning 2769' from DER, 212' right of centerline, up to 777' MSL.

Trees beginning 2930' from DER, 518' right of centerline, up to 784' MSL.

Trees beginning 3019' from DER, 34' right of centerline, up to 785' MSL.

Transmission line 5295' from DER, 1206' right of centerline, 90' AGL/804' MSL.

Tank 1.1 NM from DER, 741' right of centerline, up to 167' AGL/885' MSL.

22 FEB 2024 to 21 MAR 2024

22 FEB 2024 to 21 MAR 2024

TAKEOFF MINIMUMS, (OBSTACLE) DEPARTURE PROCEDURES, AND DIVERSE VECTOR AREA (RADAR VECTORS)

23278

EC-3

TAKEOFF MINIMUMS, (OBSTACLE) DEPARTURE PROCEDURES, AND DIVERSE VECTOR AREA (RADAR VECTORS)

23278

MILWAUKEE, WI (CON'T)

LAWRENCE J. TIMMERMAN (MWC)

TAKEOFF MINIMUMS AND (OBSTACLE) DEPARTURE PROCEDURES

AMDT 1B 14NOV13 (13318) (FAA)

TAKEOFF MINIMUMS:

Rwys 4R, 15R, 22L, 33L, N/A Environmental and obstacles.

DEPARTURE PROCEDURE:

Rwy 4L, climb heading 038° to 2100 before turning East.

Rwy 15L, climb heading 148° to 2100 before turning East.

Rwy 22R, climb heading 218° to 2100 before turning East.

Rwy 33R, climb heading 328° to 2100 before turning East.

TAKEOFF OBSTACLE NOTES:

Rwy 4L, transmission line 5082' from DER, 917' left of centerline, 133' AGL/878' MSL.

Building 75' from DER, 480' left of centerline, 33' AGL/771' MSL.

Fence 197' from DER, 381' left of centerline, 6' AGL/745' MSL.

Billboard 565' from DER, 176' left of centerline, 17' AGL/755' MSL.

AC equipment 926' from DER, 741' left of centerline, 70' AGL/808' MSL.

Tree 1106' from DER, 731' right of centerline, 70' AGL/808' MSL.

Building 887' from DER, 641' left of centerline, 67' AGL/805' MSL.

Numerous trees beginning 623' from DER, right and left of centerline, up to 100' AGL/820' MSL.

Vehicle on road 517' from DER on centerline, 17' AGL/755' MSL.

Rwy 15L, vehicles on road beginning 628' from DER, 186' left of centerline, up to 31' AGL/780' MSL.

Pole 1549' from DER, 462' right of centerline, 41' AGL/796' MSL.

Poles and lights beginning 958' from DER, 281' left of centerline, up to 51' AGL/801' MSL.

Lights beginning 1421' from DER, 512' right of centerline, up to 42' AGL/797' MSL.

Antenna on building 437' from DER, 264' left of centerline, 12' AGL/756' MSL.

Billboard 816' from DER, 297' left of centerline, 31' AGL/775' MSL.

Trees beginning 487' from DER, 397' left of centerline, up to 67' AGL/817' MSL.

Trees beginning 1203' from DER, 247' left of centerline, up to 85' AGL/835' MSL.

Trees beginning 583' from DER, 165' right of centerline, up to 50' AGL/791' MSL.

Trees beginning 1186' from DER, 184' right of centerline, up to 76' AGL/831' MSL.

Trees beginning 2297' from DER, left and right of centerline, up to 86' AGL/841' MSL.

Rwy 22R, trees beginning 553' from DER, right and left of centerline, up to 100' AGL/820' MSL.

Rwy 33R, trees beginning 495' from DER, 18' left of centerline, up to 100' AGL/797' MSL.

Tree 1257' from DER, 130' right of centerline, 100' AGL/783' MSL.

MINERAL POINT, WI

IOWA COUNTY (MRJ)

TAKEOFF MINIMUMS AND (OBSTACLE) DEPARTURE PROCEDURES

ORIG 20OCT11 (11293) (FAA)

TAKEOFF OBSTACLE NOTES:

Rwy 4, trees beginning 503' from DER, 103' right of centerline, up to 100' AGL/1289' MSL.

Trees beginning 2199' from DER, 667' left of centerline, up to 100' AGL/1279' MSL.

Rwy 11, trees beginning 95' from DER, 79' right of centerline, up to 100' AGL/1259' MSL.

Trees beginning 467' from DER, 517' left of centerline, up to 100' AGL/1259' MSL.

Rwy 22, vehicles on road beginning 102' from DER, left and right of centerline, up to 15' AGL/1184' MSL.

Trees beginning 324' from DER, 40' right of centerline, up to 100' AGL/1279' MSL.

Tree 1241' from DER, 627' left of centerline, 100' AGL/1239' MSL.

Rwy 29, trees beginning 536' from DER, 497' right of centerline, up to 100' AGL/1179' MSL.

Trees beginning 1319' from DER, 571' left of centerline, up to 100' AGL/1209' MSL.

MINOCQUA-WOODRUFF, WI

LAKELAND/NOBLE F LEE MEML FLD (ARV)

TAKEOFF MINIMUMS AND (OBSTACLE) DEPARTURE PROCEDURES

ORIG 17DEC09 (21224) (FAA)

TAKEOFF OBSTACLE NOTES:

Rwy 10, trees beginning 239' from DER, 545' right of centerline, up to 100' AGL/1729' MSL.

Trees beginning 424' from DER, 576' left of centerline, up to 100' AGL/1729' MSL.

Rwy 18, trees beginning 785' from DER, 482' right of centerline, up to 100' AGL/1729' MSL.

Trees beginning 825' from DER, 506' left of centerline, up to 100' AGL/1729' MSL.

Rwy 28, trees beginning 659' from DER, 564' right of centerline, up to 100' AGL/1729' MSL.

Trees beginning 474' from DER, 432' left of centerline, up to 100' AGL/1729' MSL.

Rwy 36, trees and windsock beginning 157' from DER, 5' right of centerline, up to 96' AGL/1725' MSL.

Trees beginning 1280' from DER, 29' left of centerline, up to 100' AGL/1749' MSL.

TAKEOFF MINIMUMS, (OBSTACLE) DEPARTURE PROCEDURES, AND DIVERSE VECTOR AREA (RADAR VECTORS)

23278

TAKEOFF MINIMUMS, (OBSTACLE) DEPARTURE PROCEDURES, AND DIVERSE VECTOR AREA (RADAR VECTORS)

23278

MOLINE, IL

QUAD CITIES INTL (MLI)

TAKEOFF MINIMUMS AND (OBSTACLE) DEPARTURE PROCEDURES

AMDT 3 23FEB23 (23054) (FAA)

TAKEOFF MINIMUMS:

- Rwy 5**, 300-1 or std. w/min. climb of 490' per NM to 800.
- Rwy 9**, 300-1¼ or std. w/min. climb of 315' per NM to 900.
- Rwy 13**, 300-1½ or std. w/min. climb of 350' per NM to 900.
- Rwy 23**, 300-1¾ or std. w/min. climb of 705' per NM to 800.

DEPARTURE PROCEDURE:

- Rwy 5**, climb on heading 048° to 2100 before turning left.
- Rwy 9**, climb on heading 090° to 1500 before turning left.
- Rwy 13**, climb on heading 126° to 1200 before turning.
- Rwy 23**, climb on heading 228° to 1200 before turning.
- Rwy 27**, climb on heading 270° to 1200 before turning.
- Rwy 31**, climb on heading 306° to 1600 before turning.

TAKEOFF OBSTACLE NOTES:

- Rwy 5**, sign 10' from DER, 113' right of centerline, 3' AGL/584' MSL.
- Pole 1167' from DER, 738' left of centerline, 56' AGL/643' MSL.
- Tower, pole beginning 1223' from DER, 673' left of centerline, up to 75' AGL/656' MSL.
- Tree 2514' from DER, 819' left of centerline, 685' MSL.
- Antenna 2593' from DER, 1082' left of centerline, 134' AGL/741' MSL.
- Tower 2596' from DER, 1116' left of centerline, 130' AGL/737' MSL.
- Rwy 9**, lighting 10' from DER, 5' left of centerline, 1' AGL/575' MSL.
- Lighting 11' from DER, 4' right of centerline, 1' AGL/575' MSL.
- Pole 772' from DER, 683' left of centerline, 30' AGL/596' MSL.
- Trees beginning 4376' from DER, 1463' right of centerline, up to 735' MSL.
- Trees beginning 4557' from DER, 1432' right of centerline, up to 752' MSL.
- Trees beginning 4807' from DER, 1468' right of centerline, up to 756' MSL.
- Trees beginning 5106' from DER, 1722' right of centerline, up to 763' MSL.
- Tree 5652' from DER, 1960' right of centerline, 749' MSL.
- Rwy 13**, tree 1408' from DER, 663' right of centerline, 645' MSL.
- Trees beginning 1582' from DER, 432' right of centerline, up to 647' MSL.
- Trees beginning 1591' from DER, 718' right of centerline, up to 661' MSL.
- Trees beginning 1923' from DER, 719' right of centerline, up to 674' MSL.
- Tree 2785' from DER, 927' right of centerline, 679' MSL.
- Trees beginning 2828' from DER, 573' right of centerline, up to 685' MSL.
- Tree 3059' from DER, 1173' right of centerline, 686' MSL.
- Trees beginning 3233' from DER, 330' right of centerline, up to 707' MSL.
- Tree 3420' from DER, 1343' right of centerline, 708' MSL.
- Trees, terrain beginning 3479' from DER, 295' right of centerline, up to 732' MSL.
- Trees beginning 3842' from DER, 291' right of centerline, up to 740' MSL.
- Trees beginning 4099' from DER, 127' right of centerline, up to 750' MSL.
- Trees beginning 4248' from DER, 47' right of centerline, up to 756' MSL.
- Tree, pole, building beginning 4400' from DER, 127' right of centerline, up to 771' MSL.
- Trees beginning 4648' from DER, 169' right of centerline, up to 772' MSL.
- Tree 4650' from DER, 190' left of centerline, 709' MSL.
- Trees beginning 4817' from DER, 1161' right of centerline, up to 779' MSL.
- Trees beginning 4993' from DER, 281' right of centerline, up to 784' MSL.
- Transmission line beginning 5299' from DER, 405' left of centerline, up to 149' AGL/738' MSL.
- Trees beginning 5882' from DER, 1918' left of centerline, up to 763' MSL.
- Trees beginning 6014' from DER, 1151' left of centerline, up to 767' MSL.
- Transmission line, trees beginning 1 NM from DER, 1843' right of centerline, up to 70' AGL/785' MSL.
- Trees beginning 1.1 NM from DER, 1435' left of centerline, up to 777' MSL.
- Trees beginning 1.1 NM from DER, 1558' right of centerline, up to 800' MSL.
- Trees beginning 1.2 NM from DER, 1420' left of centerline, up to 789' MSL.
- Trees beginning 1.3 NM from DER, 1657' left of centerline, up to 792' MSL.
- Rwy 23**, tree 1573' from DER, 733' left of centerline, 663' MSL.
- Tree 1607' from DER, 810' right of centerline, 635' MSL.
- Tree 1623' from DER, 759' left of centerline, 676' MSL.
- Tree 1714' from DER, 784' left of centerline, 706' MSL.
- Tree 1717' from DER, 683' right of centerline, 643' MSL.
- Trees beginning 1771' from DER, 560' left of centerline, up to 734' MSL.
- Tree 1812' from DER, 858' left of centerline, 735' MSL.
- Tree, pole beginning 1832' from DER, 276' left of centerline, up to 737' MSL.
- Trees beginning 1833' from DER, 550' right of centerline, up to 645' MSL.
- Trees beginning 1904' from DER, 92' right of centerline, up to 663' MSL.
- Trees beginning 2560' from DER, 216' left of centerline, up to 743' MSL.
- Tree 2755' from DER, 205' right of centerline, 666' MSL.
- Tree 2756' from DER, 21' right of centerline, 674' MSL.
- Trees beginning 2813' from DER, 238' left of centerline, up to 751' MSL.
- Trees beginning 2972' from DER, 193' right of centerline, up to 698' MSL.
- Tree, pole beginning 3082' from DER, 49' left of centerline, up to 754' MSL.

CON'T

22 FEB 2024 to 21 MAR 2024

22 FEB 2024 to 21 MAR 2024

TAKEOFF MINIMUMS, (OBSTACLE) DEPARTURE PROCEDURES, AND DIVERSE VECTOR AREA (RADAR VECTORS)

23278

TAKEOFF MINIMUMS, (OBSTACLE) DEPARTURE PROCEDURES, AND DIVERSE VECTOR AREA (RADAR VECTORS)

23278

MOLINE, IL (CON'T)

QUAD CITIES INTL (MLI) (CON'T)

Rwy 23 (CON'T), trees beginning 3109' from DER, 132' right of centerline, up to 729' MSL.

Tree, pole, building beginning 3261' from DER, 16' left of centerline, up to 773' MSL.

Trees beginning 3594' from DER, 39' right of centerline, up to 739' MSL.

Tree 4537' from DER, 373' right of centerline, 745' MSL.

Tree 4546' from DER, 183' right of centerline, 748' MSL.

Tree, building beginning 4550' from DER, 76' right of centerline, up to 749' MSL.

Trees beginning 5193' from DER, 29' right of centerline, up to 754' MSL.

Transmission line beginning 1.3 NM from DER, 742' left of centerline, up to 107' AGL/807' MSL.

Rwy 27, lighting 9' from DER, 5' left of centerline, 1' AGL/579' MSL.

Lighting 10' from DER, 4' right of centerline, 1' AGL/579' MSL.

Rwy 31, lighting 39' from DER, 150' right of centerline, 3' AGL/586' MSL.

Tree 1644' from DER, 270' left of centerline, 629' MSL.

Tree 2712' from DER, 263' right of centerline, 654' MSL.

MONEE, IL

BULT FLD (C56)

TAKEOFF MINIMUMS AND (OBSTACLE) DEPARTURE PROCEDURES

ORIG 12MAR09 (22027) (FAA)

TAKEOFF OBSTACLE NOTES:

Rwy 9, vehicle on road 145' from DER, on centerline, 15' AGL/785' MSL.

Rwy 27, vehicle on road 150' from DER, on centerline, 15' AGL/797' MSL.

Metal chimney 305' from DER, 210' left of centerline, 29' AGL/812' MSL.

Tree 367' from DER, 161' left of centerline, 40' AGL/819' MSL.

Pole barn 421' from DER, 202' left of centerline, 22' AGL/801' MSL.

Trees beginning 1484' from DER, 223' right of centerline, up to 100' AGL/859' MSL.

MONMOUTH, IL

MONMOUTH MUNI (C66)

TAKEOFF MINIMUMS AND (OBSTACLE) DEPARTURE PROCEDURES

AMDT 2B 22JUN17 (17173) (FAA)

TAKEOFF MINIMUMS:

Rwy 21, 400-2½ or std. w/min. climb of 321' per NM to 1200.

TAKEOFF OBSTACLE NOTES:

Rwy 3, vehicle on road beginning at DER, 201' right of centerline, 15' AGL/764' MSL.

Trees beginning at DER, 251' right of centerline, up to 100' AGL/849' MSL.

Trees beginning 841' from DER, left and right of centerline, up to 100' AGL/849' MSL.

Rwy 21, vehicle on road, beginning 347' from DER, left and right of centerline, 17' AGL/776' MSL.

Trees beginning 449' from DER, left and right of centerline, up to 100' AGL/859' MSL.

MONROE, WI

MONROE MUNI (EFT)

TAKEOFF MINIMUMS AND (OBSTACLE) DEPARTURE PROCEDURES

AMDT 2 07MAY09 (09127) (FAA)

TAKEOFF OBSTACLE NOTES:

Rwy 2, vehicle on road 926' from DER, left and right of centerline, up to 17' AGL/1116' MSL.

Trees beginning 182' from DER, 175' right of centerline, up to 100' AGL/1169' MSL.

Rwy 12, trees beginning 1234' from DER, 655' right of centerline, up to 100' AGL/1189' MSL.

Rwy 20, trees beginning 712' from DER, 288' right of centerline, up to 100' AGL/1129' MSL.

Rwy 30, trees beginning 1918' from DER, 87' right of centerline, up to 100' AGL/1209' MSL.

Vehicle on road 1166' from DER, 157' right of centerline, up to 17' AGL/1126' MSL.

MORRIS, IL

MORRIS MUNI - JAMES R WASHBURN FLD (C09)

TAKEOFF MINIMUMS AND (OBSTACLE) DEPARTURE PROCEDURES

AMDT 1 22JUN17 (22139) (FAA)

TAKEOFF MINIMUMS:

Rwy 18, 300-1¼ or std. w/min. climb of 265' per NM to 1000.

TAKEOFF OBSTACLE NOTES:

Rwy 18, tower 1.39 NM from DER, 86' left of centerline, 290' AGL/839' MSL.

Terrain 6' from DER, 7' left of centerline, 565' MSL.

Rwy 36, vehicle on road beginning 382' from DER, 371' right of centerline, 15' AGL/605' MSL.

Trees beginning 1019' from DER, 469' right of centerline, up to 78' AGL/653' MSL.

Trees beginning 1960' from DER, 17' left of centerline, up to 102' AGL/675' MSL.

TAKEOFF MINIMUMS, (OBSTACLE) DEPARTURE PROCEDURES, AND DIVERSE VECTOR AREA (RADAR VECTORS)

23278

TAKEOFF MINIMUMS, (OBSTACLE) DEPARTURE PROCEDURES, AND DIVERSE VECTOR AREA (RADAR VECTORS)

23278

MOSINEE, WI

CENTRAL WISCONSIN (CWA)

TAKEOFF MINIMUMS AND (OBSTACLE) DEPARTURE PROCEDURES

AMDT 3 10AUG23 (23222) (FAA)

DEPARTURE PROCEDURE:

Rwy 35, climb on heading 335° to 3000 before turning right.

TAKEOFF OBSTACLE NOTES:

Rwy 8, tree 156' from DER, 520' right of centerline, 1276' MSL.

Tree 607' from DER, 636' right of centerline, 1282' MSL.

Tree 738' from DER, 676' right of centerline, 1283' MSL.

Rwy 26, terrain 13' from DER, 388' right of centerline, 1275' MSL.

Sign beginning 26' from DER, 95' right of centerline, up to 3' AGL/1277' MSL.

Sign 43' from DER, 95' left of centerline, 3' AGL/1276' MSL.

Vertical point, utility building beginning 124' from DER, 449' right of centerline, up to 4' AGL/1278' MSL.

Utility building 125' from DER, 448' right of centerline, 5' AGL/1279' MSL.

Fence 150' from DER, 502' right of centerline, 8' AGL/1284' MSL.

Fence beginning 152' from DER, 176' right of centerline, up to 9' AGL/1286' MSL.

Fence beginning 179' from DER, 103' left of centerline, up to 10' AGL/1283' MSL.

Tree 1819' from DER, 789' right of centerline, 1324' MSL.

Trees beginning 1888' from DER, 658' right of centerline, up to 1326' MSL.

Trees beginning 1927' from DER, 756' right of centerline, up to 1333' MSL.

Tree 2247' from DER, 883' right of centerline, 1338' MSL.

Tree 2252' from DER, 1015' right of centerline, 1341' MSL.

Trees beginning 2351' from DER, 930' right of centerline, up to 1342' MSL.

Rwy 35, utility building, vertical point beginning 39' from DER, 153' right of centerline, up to 5' AGL/1279' MSL.

Light poles 39' from DER, 152' left of centerline, 1278' MSL.

Fence beginning 62' from DER, 125' right of centerline, up to 9' AGL/1286' MSL.

Wind indicator 509' from DER, 443' right of centerline, 26' AGL/1302' MSL.

Pole 513' from DER, 443' right of centerline, 23' AGL/1303' MSL.

Pole 912' from DER, 695' right of centerline, 25' AGL/1311' MSL.

NAVAID 1042' from DER, 250' left of centerline, 17' AGL/1306' MSL.

Poles beginning 1098' from DER, 656' right of centerline, up to 27' AGL/1315' MSL.

Pole 1335' from DER, 831' right of centerline, 30' AGL/1318' MSL.

Tree 1404' from DER, 670' right of centerline, 1319' MSL.

Pole, trees beginning 1513' from DER, 693' right of centerline, up to 38' AGL/1327' MSL.

Tree 1869' from DER, 958' right of centerline, 1328' MSL.

Tower, tree beginning 1995' from DER, 867' right of centerline, up to 47' AGL/1349' MSL.

Tree 2500' from DER, 367' left of centerline, 1346' MSL.

Tower 2714' from DER, 857' right of centerline, 44' AGL/1356' MSL.

Smokestack 2838' from DER, 862' right of centerline, 46' AGL/1359' MSL.

Smokestack 3248' from DER, 1353' right of centerline, 72' AGL/1372' MSL.

MOUNT CARMEL, IL

MOUNT CARMEL MUNI (AJG)

TAKEOFF MINIMUMS AND (OBSTACLE) DEPARTURE PROCEDURES

AMDT 1 03APR14 (14093) (FAA)

TAKEOFF MINIMUMS:

Rwy 22, 300-1 or std. w/min. climb of 325' per NM to 700.

Rwy 31, 300-1 or std. w/min. climb of 225' per NM to 700, or alternatively, with std. takeoff minimums and a normal 200' per NM climb gradient, takeoff must occur no later than 1600' prior to DER.

TAKEOFF OBSTACLE NOTES:

Rwy 4, vehicle on road 409' from DER, 170' left of centerline, up to 15' AGL/404' MSL.

Trees 3718' from DER, 130' right of centerline, 85' AGL/525' MSL.

Rwy 13, vehicle on road 7' from DER, 190' right of centerline, 15' AGL/445' MSL.

Trees beginning 2438' from DER, 839' right of centerline, up to 100' AGL/542' MSL.

REIL 41' from DER, 112' left of centerline, 1' AGL/413' MSL.

Rwy 22, ground beginning 194' from DER, 262' right of centerline, up to 459' MSL.

Trees beginning 535' from DER, 146' right of centerline, up to 90' AGL/587' MSL.

Tree 81' from DER, 146' right of centerline, 19' AGL/448' MSL.

Antenna on grain elevator 4403' from DER, 378' left of centerline, 100' AGL/606' MSL.

Rwy 31, poles beginning 1812' from DER, 318' left of centerline, up to 55' AGL/484' MSL.

Trees beginning 2886' from DER, 112' left of centerline, up to 98' AGL/527' MSL.

Trees beginning 3657' from DER, 217' right of centerline, up to 91' AGL/580' MSL.

MOUNT STERLING, IL

MOUNT STERLING MUNI (I63)

TAKEOFF MINIMUMS AND (OBSTACLE) DEPARTURE PROCEDURES

ORIG 02JUL09 (09183) (FAA)

TAKEOFF OBSTACLE NOTES:

Rwy 18, trees beginning 1555' from DER, 309' right of centerline, up to 95' AGL/784' MSL.

Tree 2243' from DER, 856' left of centerline, 100' AGL/819' MSL.

Rwy 36, vehicle on road and pole 686' from DER, 486' right of centerline, up to 60' AGL/779' MSL.

Vehicle on road and trees beginning 679' from DER, 365' left of centerline, up to 100' AGL/839' MSL.

TAKEOFF MINIMUMS, (OBSTACLE) DEPARTURE PROCEDURES, AND DIVERSE VECTOR AREA (RADAR VECTORS)

23278

TAKEOFF MINIMUMS, (OBSTACLE) DEPARTURE PROCEDURES, AND DIVERSE VECTOR AREA (RADAR VECTORS)

23278

MOUNT VERNON, IL

MOUNT VERNON (MVN)

TAKEOFF MINIMUMS AND (OBSTACLE) DEPARTURE PROCEDURES

ORIG 15MAR07 (07074) (FAA)

DEPARTURE PROCEDURE:

Rwy 33, climb via heading 331° to 1300 before turning left.

TAKEOFF OBSTACLE NOTES:

Rwy 5, multiple trees beginning 1615' from DER, 7' left of centerline, up to 134' AGL/602' MSL,

Antenna 2477' from DER, 990' right of centerline, 79' AGL/547' MSL.

Tree 3329' from DER, 519' right of centerline, 98' AGL/566' MSL.

Rwy 15, multiple trees beginning 712' from DER, 17' right of centerline, up to 71' AGL/529' MSL.

Tree 908' from DER, 465' left of centerline, 70' AGL/527' MSL.

Railroad 608' from DER, 159' right of centerline, 23' AGL/479' MSL.

Road 564' from DER, 3' right of centerline, 15' AGL/472' MSL.

Rwy 23, multiple trees beginning 1705' from DER, 102' right of centerline, up to 72' AGL/539' MSL.

Tree 1797' from DER, 158' left of centerline, 57' AGL/524' MSL.

Railroad 238' from DER, 500' left of centerline, 23' AGL/485' MSL.

Multiple roads beginning 12' from DER, 367' left of centerline, up to 15' AGL/479' MSL.

Fencepost 291' from DER, 426' right of centerline, 9' AGL/476' MSL.

Rwy 33, multiple trees beginning 696' from DER, 130' right of centerline, up to 93' AGL/573' MSL.

Multiple trees beginning 689' from DER, 216' left of centerline, up to 105' AGL/585' MSL.

NECEDAH, WI

NECEDAH (DAF)

TAKEOFF MINIMUMS AND (OBSTACLE) DEPARTURE PROCEDURES

ORIG 22SEP11 (11265) (FAA)

TAKEOFF OBSTACLE NOTES:

Rwy 18, road beginning at DER, left and right of centerline, up to 15' AGL/934' MSL.

Trees and buildings beginning at DER, 446' left of centerline, up to 100' AGL/1019' MSL.

Trees and buildings beginning at DER, 317' right of centerline, up to 100' AGL/1019' MSL.

Rwy 36, trees beginning 711' from DER, 687' left of centerline, up to 100' AGL/1021' MSL.

Power lines, building and railroad beginning 19' from DER, 268' right of centerline, up to 100' AGL/1012' MSL.

NEILLSVILLE, WI

NEILLSVILLE MUNI (VIQ)

TAKEOFF MINIMUMS AND (OBSTACLE) DEPARTURE PROCEDURES

ORIG-A 02DEC21 (21336) (FAA)

TAKEOFF OBSTACLE NOTES:

Rwy 10, tree, NAVAID beginning 9' from DER, 30' right of centerline, up to 1252' MSL.

Tree 159' from DER, 528' left of centerline, 1268' MSL.

Trees beginning 417' from DER, 550' left of centerline, up to 1272' MSL.

Tree 774' from DER, 564' left of centerline, 1281' MSL.

Trees beginning 902' from DER, 60' left of centerline, up to 1308' MSL.

Trees beginning 961' from DER, 19' right of centerline, up to 1264' MSL.

Tree 1063' from DER, 772' right of centerline, 1274' MSL.

Trees, vehicle on road beginning 1647' from DER, 309' left of centerline, up to 1309' MSL.

Poles, tree beginning 2152' from DER, 171' left of centerline, up to 34' AGL/1318' MSL.

Trees, pole beginning 2274' from DER, 209' left of centerline, up to 1321' MSL.

Pole 2295' from DER, 145' right of centerline, 33' AGL/1297' MSL.

Pole 2351' from DER, 138' right of centerline, 34' AGL/1302' MSL.

Trees, building, pole, elevator, tank beginning 2375' from DER, 6' right of centerline, up to 1340' MSL.

Tree 2573' from DER, 15' left of centerline, 1330' MSL.

Trees beginning 2660' from DER, 121' left of centerline, up to 1340' MSL.

Tree 2928' from DER, 1146' left of centerline, 1348' MSL.

Trees beginning 3232' from DER, 179' right of centerline, up to 1352' MSL.

Tree 3542' from DER, 998' left of centerline, 1352' MSL.

Trees beginning 3563' from DER, 546' left of centerline, up to 1358' MSL.

Trees beginning 3582' from DER, 275' right of centerline, up to 1371' MSL.

Rwy 28, tree 5' from DER, 219' left of centerline, 1213' MSL.

Terrain 147' from DER, 373' right of centerline, 1212' MSL.

Poles, tree beginning 349' from DER, 460' right of centerline, up to 41' AGL/1252' MSL.

Trees beginning 861' from DER, 149' left of centerline, up to 1233' MSL.

Trees beginning 950' from DER, 218' right of centerline, up to 1253' MSL.

22 FEB 2024 to 21 MAR 2024

22 FEB 2024 to 21 MAR 2024

TAKEOFF MINIMUMS, (OBSTACLE) DEPARTURE PROCEDURES, AND DIVERSE VECTOR AREA (RADAR VECTORS)

23278

EC-3

**TAKEOFF MINIMUMS, (OBSTACLE) DEPARTURE PROCEDURES, AND
DIVERSE VECTOR AREA (RADAR VECTORS)**

23278

NEW HOLSTEIN, WI

NEW HOLSTEIN MUNI (8D1)

TAKEOFF MINIMUMS AND (OBSTACLE) DEPARTURE PROCEDURES

ORIG 20OCT11 (11293) (FAA)

TAKEOFF MINIMUMS:

Rwys 4, 22, NA - Environmental.**Rwy 32**, 300-1 or std. w/min. climb of 350' per NM to 1200.

TAKEOFF OBSTACLE NOTES:

Rwy 14, rising terrain beginning 135' from DER, 187' left of centerline, up to 985' MSL.

Terrain with trees beginning 143' from DER, left and right of centerline, up to 100' AGL/1117' MSL.

Rwy 32, vehicles on road beginning 6' from DER, 19' right of centerline, up to 19' AGL/998' MSL.

Poles beginning 332' from DER, left and right of centerline, up to 37' AGL/1033' MSL.

Terrain with trees beginning 561' from DER, left and right of centerline, up to 100' AGL/1129' MSL.

NEW LISBON, WI

MAUSTON/NEW LISBON UNION (82C)

TAKEOFF MINIMUMS AND (OBSTACLE) DEPARTURE PROCEDURES

ORIG-A 05MAR15 (21336) (FAA)

TAKEOFF MINIMUMS:

Rwys 14, 32, 400-1 or std. with a min. climb of 220' per NM to 1400.

TAKEOFF OBSTACLE NOTES:

Rwy 14, vehicle on road beginning 22' from DER, 153' left of centerline, up to 15' AGL/907' MSL.

Trees beginning 20' from DER, 15' right of centerline, up to 87' AGL/987' MSL.

Trees beginning 715' from DER, 39' left of centerline, up to 95' AGL/985' MSL.

Rwy 32, fence beginning 67' from DER, 300' right of centerline, up to 6' AGL/918' MSL.

Vehicle on road beginning 72' from DER, 5' right and left of centerline, up to 15' AGL/954' MSL.

Trees beginning 110' from DER, 146' left and right of centerline, up to 97' AGL/1007' MSL.

Terrain beginning 190' from DER, 43' left and right of centerline, up to 941' MSL.

Buildings beginning 2202' from DER, 398' left and right of centerline, up to 64' AGL/981' MSL.

NEW RICHMOND, WI

NEW RICHMOND RGNL (RNH)

TAKEOFF MINIMUMS AND (OBSTACLE) DEPARTURE PROCEDURES

ORIG-A 23JUL15 (15204) (FAA)

TAKEOFF MINIMUMS:

Rwy 4, 22, NA-Environmental.

TAKEOFF OBSTACLE NOTES:

Rwy 14, multiple trees beginning 810' from DER, 230' left of centerline, up to 100' AGL/1099' MSL.

Vehicle on road 502' from DER, 612' left of centerline, 15' AGL/1014' MSL.

Rwy 32, vehicle on road 425' from DER, 591' left of centerline, 15' AGL/1014' MSL.

Multiple trees beginning 1460' from DER, 443' right of centerline, up to 100' AGL/1099' MSL.

OCONTO, WI

OCONTO/J DOUGLAS BLAKE MUNI (OCQ)

TAKEOFF MINIMUMS AND (OBSTACLE) DEPARTURE PROCEDURES

ORIG 30JUN11 (21336) (FAA)

TAKEOFF MINIMUMS:

Rwys 4, 22, NA-ATC.

TAKEOFF OBSTACLE NOTES:

Rwy 11, trees beginning 8' from DER, left and right of centerline, up to 91' AGL/693' MSL**Rwy 29**, trees beginning 342' from DER, left and right of centerline, up to 80' AGL/684' MSL.

Vehicle on road beginning 182' from DER, 286' right of centerline, 15' AGL/619' MSL.

Fence 340' from DER, 553' left of centerline, 9' AGL/614' MSL.

REIL 14' from DER, 76' left of centerline, 1' AGL/605' MSL.

22 FEB 2024 to 21 MAR 2024

22 FEB 2024 to 21 MAR 2024

**TAKEOFF MINIMUMS, (OBSTACLE) DEPARTURE PROCEDURES, AND
DIVERSE VECTOR AREA (RADAR VECTORS)**

23278

EC-3

TAKEOFF MINIMUMS, (OBSTACLE) DEPARTURE PROCEDURES, AND DIVERSE VECTOR AREA (RADAR VECTORS)

23278

OLNEY-NOBLE, IL OLNEY-NOBLE (OLY)

TAKEOFF MINIMUMS AND (OBSTACLE) DEPARTURE PROCEDURES

ORIG-A 20JUN19 (19171) (FAA)

TAKEOFF OBSTACLE NOTES:

Rwy 4, trees beginning 112' from DER, 416' left of centerline, up to 72' AGL/519' MSL.

Trees beginning 387' from DER, 326' left of centerline, up to 525' MSL.

Tree 546' from DER, 455' left of centerline, 530' MSL.

Trees beginning 659' from DER, 353' left of centerline, up to 536' MSL.

Tree 731' from DER, 561' right of centerline, 512' MSL.

Trees beginning 752' from DER, 33' right of centerline, up to 515' MSL.

Trees beginning 1120' from DER, 49' left of centerline, up to 539' MSL.

Trees beginning 1307' from DER, 285' right of centerline, up to 525' MSL.

Tree 2147' from DER, 846' right of centerline, 526' MSL.

Tree 2357' from DER, 8' right of centerline, 538' MSL.

Tree 2377' from DER, 304' right of centerline, 539' MSL.

Rwy 11, tree 484' from DER, 500' left of centerline, 503' MSL.

Trees beginning 646' from DER, 6' left of centerline, up to 513' MSL.

Tree 872' from DER, 611' right of centerline, 497' MSL.

Trees beginning 1065' from DER, 127' right of centerline, up to 533' MSL.

Trees beginning 1328' from DER, 797' left of centerline, up to 518' MSL.

Trees beginning 1783' from DER, 731' left of centerline, up to 536' MSL.

Trees beginning 1918' from DER, 303' left of centerline, up to 559' MSL.

Trees beginning 2140' from DER, 579' left of centerline, up to 125' AGL/576' MSL.

Rwy 22, vehicles on road, terrain beginning 3' from DER, 124' left of centerline, up to 477' MSL.

Vehicles on road 34' from DER, 20' left of centerline, 479' MSL.

Vehicles on road 46' from DER, 87' right of centerline, 477' MSL.

Vehicles on road beginning 186' from DER, 185' right of centerline, up to 15' AGL/483' MSL.

Vehicles on road beginning 372' from DER, 30' right of centerline, up to 484' MSL.

Pole 685' from DER, 644' left of centerline, 42' AGL/509' MSL.

Pole, tree beginning 854' from DER, 487' left of centerline, up to 43' AGL/510' MSL.

Tree 1117' from DER, 742' left of centerline, 545' MSL.

Tree 1567' from DER, 441' right of centerline, 518' MSL.

Tree 1657' from DER, 567' right of centerline, 524' MSL.

Trees beginning 1739' from DER, 245' right of centerline, up to 531' MSL.

Tree 2096' from DER, 970' right of centerline, 546' MSL.

Rwy 29, tree 181' from DER, 515' right of centerline, 33' AGL/512' MSL.

Tree 213' from DER, 508' right of centerline, 516' MSL.

Tree 329' from DER, 476' right of centerline, 75' AGL/553' MSL.

Trees beginning 790' from DER, 521' left of centerline, up to 525' MSL.

Tree 3062' from DER, 1093' left of centerline, 560' MSL.

Tree 3083' from DER, 992' left of centerline, 563' MSL.

Tree 3174' from DER, 846' left of centerline, 564' MSL.

OSCEOLA, WI

L.O. SIMENSTAD MUNI (OEO)

TAKEOFF MINIMUMS AND (OBSTACLE) DEPARTURE PROCEDURES

ORIG 15MAR07 (07074) (FAA)

TAKEOFF MINIMUMS:

Rwys 4, 22, NA-environmental.

TAKEOFF OBSTACLE NOTES:

Rwy 10, multiple trees beginning 9951' from DER, 3135' right of centerline, up to 100' AGL/1159' MSL.

Multiple trees beginning 1785' from DER, 932' left of centerline, up to 100' AGL/1149' MSL.

Rwy 28, multiple trees beginning 3534' from DER, 1277' right of centerline, up to 100' AGL/979' MSL.

Truck on road beginning 421' from DER 71' left of centerline, 15' AGL/904' MSL.

22 FEB 2024 to 21 MAR 2024

22 FEB 2024 to 21 MAR 2024

TAKEOFF MINIMUMS, (OBSTACLE) DEPARTURE PROCEDURES, AND DIVERSE VECTOR AREA (RADAR VECTORS)

23278

EC-3

TAKEOFF MINIMUMS, (OBSTACLE) DEPARTURE PROCEDURES, AND DIVERSE VECTOR AREA (RADAR VECTORS)

23278

OSHKOSH, WI

WITTMAN RGNL (OSH)

TAKEOFF MINIMUMS AND (OBSTACLE) DEPARTURE PROCEDURES

AMDT 1A 29DEC22 (22363) (FAA)

TAKEOFF OBSTACLE NOTES:

Rwy 5, trees beginning 69' from DER, 364' left of centerline, up to 793' MSL.
 Pole, traverse way, tree beginning 198' from DER, 58' left of centerline, up to 32' AGL/804' MSL.
 Traverse way 285' from DER, 502' right of centerline, 785' MSL.
 Pole, traverse way, tree beginning 357' from DER, 96' right of centerline, up to 44' AGL/814' MSL.
 Tree 462' from DER, 456' right of centerline, 56' AGL/819' MSL.
 Tree, pole, building beginning 482' from DER, 19' right of centerline, up to 52' AGL/820' MSL.
 Tree, pole beginning 760' from DER, 23' left of centerline, up to 70' AGL/838' MSL.
 Tree, pole beginning 991' from DER, 42' right of centerline, up to 821' MSL.
 Tree 1457' from DER, 37' right of centerline, 825' MSL.
 Tree, pole beginning 1612' from DER, 74' right of centerline, up to 830' MSL.
 Trees beginning 1857' from DER, 28' right of centerline, up to 840' MSL.
Rwy 9, pole 28' from DER, 485' right of centerline, 28' AGL/800' MSL.
 Building, tree, pole beginning 223' from DER, 362' right of centerline, up to 822' MSL.
 Pole, traverse way, tree beginning 461' from DER, 144' left of centerline, up to 44' AGL/814' MSL.
 Trees beginning 1228' from DER, 263' right of centerline, up to 831' MSL.
 Trees beginning 1479' from DER, 147' right of centerline, up to 835' MSL.
 Tree 1659' from DER, 668' left of centerline, 818' MSL.
 Tree 1684' from DER, 789' left of centerline, 827' MSL.
 Trees beginning 1688' from DER, 298' right of centerline, up to 839' MSL.
 Tree 1775' from DER, 459' left of centerline, 829' MSL.
 Trees beginning 1845' from DER, 503' left of centerline, up to 833' MSL.
 Tree 2012' from DER, 422' left of centerline, 837' MSL.
 Tree 2252' from DER, 423' left of centerline, 838' MSL.
 Tree 2417' from DER, 448' left of centerline, 843' MSL.
 Tree 2617' from DER, 417' left of centerline, 852' MSL.
 Tree 2858' from DER, 194' right of centerline, 110' AGL/863' MSL.
Rwy 13, building beginning 33' from DER, 452' left of centerline, up to 21' AGL/800' MSL.
 Tree, traverse way beginning 115' from DER, 140' left of centerline, up to 64' AGL/839' MSL.
 Tree, pole beginning 271' from DER, 35' left of centerline, up to 68' AGL/842' MSL.
 Traverse way beginning 279' from DER, 9' right of centerline, up to 792' MSL.
 Trees beginning 381' from DER, 3' right of centerline, up to 810' MSL.
 Tree, pole, pipeline, building, utility building beginning 511' from DER, 6' right of centerline, up to 840' MSL.
 Tree, transmission line, pole beginning 1795' from DER, 645' right of centerline, up to 841' MSL.
Rwy 18, tree 1563' from DER, 897' left of centerline, 851' MSL.
 Tree 2034' from DER, 971' left of centerline, 877' MSL.
Rwy 23, building, traverse way, tree, pole beginning 21' from DER, 287' right of centerline, up to 29' AGL/816' MSL.
 Terrain 51' from DER, 444' left of centerline, 792' MSL.
 Pole, traverse way beginning 320' from DER, 72' right of centerline, up to 30' AGL/819' MSL.
 Traverse way 520' from DER, 26' left of centerline, 806' MSL.
 Trees beginning 843' from DER, 363' left of centerline, up to 826' MSL.
 Tree 996' from DER, 583' left of centerline, 835' MSL.
 Pole 1001' from DER, 696' right of centerline, 35' AGL/827' MSL.
 Tree, pole beginning 1026' from DER, 60' left of centerline, up to 51' AGL/839' MSL.
 Pole, tree beginning 1228' from DER, 161' right of centerline, up to 45' AGL/837' MSL.
 Tree 1337' from DER, 193' right of centerline, 838' MSL.
 Tree, pole beginning 1345' from DER, 82' right of centerline, up to 844' MSL.
 Trees beginning 1355' from DER, 439' left of centerline, up to 841' MSL.
 Tree 1611' from DER, 834' left of centerline, 851' MSL.
 Light poles 2235' from DER, 708' left of centerline, 138' AGL/938' MSL.
 Control tower, transmission line, pole beginning 2241' from DER, 452' left of centerline, up to 141' AGL/941' MSL.
 Tower, tree beginning 2513' from DER, 167' right of centerline, up to 65' AGL/872' MSL.
 Tree 2793' from DER, 282' right of centerline, 877' MSL.
 Trees beginning 2938' from DER, 507' right of centerline, up to 881' MSL.
 Trees beginning 3207' from DER, 682' right of centerline, up to 882' MSL.
Rwy 27, pole, sign beginning 1204' from DER, 753' right of centerline, up to 28' AGL/833' MSL.
 Pole beginning 1795' from DER, 652' right of centerline, up to 42' AGL/845' MSL.
 Tree 2197' from DER, 382' left of centerline, 854' MSL.
 Pole 2369' from DER, 315' left of centerline, 29' AGL/862' MSL.
 Tree, pole beginning 2402' from DER, 62' left of centerline, up to 867' MSL.
 Tree 3169' from DER, 1282' right of centerline, 878' MSL.
 Pole, transmission line beginning 4253' from DER, 1540' left of centerline, up to 904' MSL.
Rwy 31, building, tower, tree, pole beginning 1132' from DER, 317' right of centerline, up to 832' MSL.
 Tree, pole beginning 1621' from DER, 193' right of centerline, up to 65' AGL/843' MSL.
Rwy 36, sign 23' from DER, 474' left of centerline, 1' AGL/791' MSL.
 NAVAJD 148' from DER, 3' left of centerline, 15' AGL/801' MSL.

22 FEB 2024 to 21 MAR 2024

22 FEB 2024 to 21 MAR 2024

TAKEOFF MINIMUMS, (OBSTACLE) DEPARTURE PROCEDURES, AND DIVERSE VECTOR AREA (RADAR VECTORS)

23278

EC-3

TAKEOFF MINIMUMS, (OBSTACLE) DEPARTURE PROCEDURES, AND DIVERSE VECTOR AREA (RADAR VECTORS)

23278

PARIS, IL

EDGAR COUNTY (PRG)

TAKEOFF MINIMUMS AND (OBSTACLE) DEPARTURE PROCEDURES

AMDT 1 21JUL16 (16203) (FAA)

TAKEOFF OBSTACLE NOTES:

Rwy 9, airfield lt 9° from DER, 11' right of centerline, 2' AGL/651' MSL.

Wsk 305' from DER, 237' right of centerline, 660' MSL.

Pole 575' from DER, 385' right of centerline, 673' MSL.

Pole 640' from DER, 321' left of centerline, 671' MSL.

Trees beginning 877' from DER, 556' left of centerline, up to 705' MSL.

Tree 1359' from DER, 634' right of centerline, 688' MSL.

Tree 1513' from DER, 628' right of centerline, 689' MSL.

Tree 1750' from DER, 334' right of centerline, 705' MSL.

Trees beginning 1775' from DER, 126' right of centerline, up to 707' MSL.

Tree 2001' from DER, 322' right of centerline, 710' MSL.

Trees beginning 2100' from DER, 406' right of centerline, up to 711' MSL.

Tree 2129' from DER, 1037' left of centerline, 711' MSL.

Tree 2243' from DER, 1052' left of centerline, 722' MSL.

Tree 2324' from DER, 1037' right of centerline, 713' MSL.

Tree 2429' from DER, 1151' right of centerline, 714' MSL.

Rwy 18, terrain 20' from DER, 18' left of centerline, 655' MSL.

Wsk 297' from DER, 235' right of centerline, 668' MSL.

Vehicles on road beginning 440' from DER, 353' right of centerline, up to 672' MSL.

Rwy 27, grd 1' from DER, 454' left of centerline, 658' MSL.

Terrain 23' from DER, 14' right of centerline, 655' MSL.

Terrain beginning 42' from DER, 361' left of centerline, up to 659' MSL.

Tree 56' from DER, 321' right of centerline, 693' MSL.

Tree 112' from DER, 439' right of centerline, 716' MSL.

Tree 195' from DER, 372' right of centerline, 79' AGL/727' MSL.

Tree and wsk beginning 266' from DER, 100' right of centerline, up to 93' AGL/729' MSL.

Trees beginning 1204' from DER, 621' left of centerline, up to 718' MSL.

Tree and pole beginning 1331' from DER, 258' left of centerline, up to 739' MSL.

Rwy 36, fence 17' from DER, 338' left of centerline, 4' AGL/648' MSL.

Wsk 301' from DER, 136' right of centerline, 656' MSL.

Trees beginning 681' from DER, 47' right of centerline, up to 720' MSL.

Trees beginning 771' from DER, 382' left of centerline, up to 705' MSL.

Trees beginning 1182' from DER, 52' left of centerline, up to 714' MSL.

PARK FALLS, WI

PARK FALLS MUNI (PKF)

TAKEOFF MINIMUMS AND (OBSTACLE) DEPARTURE PROCEDURES

AMDT 1 02DEC21 (21336) (FAA)

TAKEOFF MINIMUMS:

Rwy 18, 300-2¼ or std. w/min. climb of 210' per NM to 1900.

Rwy 36, 300-2¼ or std. w/min. climb of 300' per NM to 1700.

DEPARTURE PROCEDURE:

Rwy 18, climb on heading 184° to 2400 before turning left.

Rwy 36, climb on heading 004° to 2100 before turning right.

TAKEOFF OBSTACLE NOTES:

Rwy 18, tree 7' from DER, 488' left of centerline, 1506' MSL.

Tree 46' from DER, 151' right of centerline, 1509' MSL.

Trees beginning 86' from DER, 31' left of centerline, up to 1539' MSL.

Traverse way 96' from DER, 459' right of centerline, 1523' MSL.

Tree, traverse way beginning 105' from DER, 13' right of centerline, up to 1560' MSL.

Trees beginning 475' from DER, 2' left of centerline, up to 1569' MSL.

Tree, traverse way beginning 599' from DER, 4' right of centerline, up to 1578' MSL.

Trees beginning 725' from DER, 12' left of centerline, up to 1573' MSL.

Trees beginning 754' from DER, 47' right of centerline, up to 1594' MSL.

Trees beginning 960' from DER, 6' right of centerline, up to 1600' MSL.

Tree 2411' from DER, 33' left of centerline, 1574' MSL.

Trees beginning 2417' from DER, 5' left of centerline, up to 1579' MSL.

Trees beginning 2527' from DER, 144' left of centerline, up to 1580' MSL.

Trees beginning 2599' from DER, 58' left of centerline, up to 1591' MSL.

Trees beginning 2860' from DER, 12' right of centerline, up to 1603' MSL.

Trees beginning 3143' from DER, 38' left of centerline, up to 1595' MSL.

Trees beginning 3967' from DER, 913' right of centerline, up to 1610' MSL.

Tree 4711' from DER, 1085' right of centerline, 1620' MSL.

Tree 4739' from DER, 741' right of centerline, 1622' MSL.

CON'T

22 FEB 2024 to 21 MAR 2024

22 FEB 2024 to 21 MAR 2024

TAKEOFF MINIMUMS, (OBSTACLE) DEPARTURE PROCEDURES, AND DIVERSE VECTOR AREA (RADAR VECTORS)

23278

EC-3

TAKEOFF MINIMUMS, (OBSTACLE) DEPARTURE PROCEDURES, AND DIVERSE VECTOR AREA (RADAR VECTORS)

23278

PARK FALLS, WI (CON'T) PARK FALLS MUNI (PKF) (CON'T)

Rwy 36, tree 97' from DER, 178' right of centerline, 1508' MSL.
 Trees beginning 114' from DER, 23' left of centerline, up to 1516' MSL.
 Trees beginning 348' from DER, 173' right of centerline, up to 1516' MSL.
 Trees beginning 462' from DER, 16' right of centerline, up to 1523' MSL.
 Trees beginning 581' from DER, 78' right of centerline, up to 1529' MSL.
 Tree 761' from DER, 652' left of centerline, 1542' MSL.
 Tree 907' from DER, 641' left of centerline, 1547' MSL.
 Trees beginning 1097' from DER, 438' left of centerline, up to 1563' MSL.
 Trees beginning 1171' from DER, 425' left of centerline, up to 1575' MSL.
 Trees beginning 1404' from DER, 159' left of centerline, up to 1582' MSL.
 Trees beginning 1667' from DER, 21' left of centerline, up to 1583' MSL.
 Trees beginning 1725' from DER, 8' left of centerline, up to 1594' MSL.
 Tree 1757' from DER, 29' right of centerline, 1538' MSL.
 Tree, transmission line beginning 1762' from DER, 56' left of centerline, up to 1598' MSL.
 Trees beginning 1773' from DER, 15' right of centerline, up to 1546' MSL.
 Trees beginning 1824' from DER, 51' left of centerline, up to 1601' MSL.
 Trees beginning 1835' from DER, 36' right of centerline, up to 1553' MSL.
 Trees beginning 1879' from DER, 48' right of centerline, up to 1556' MSL.
 Tree, transmission line, pole beginning 2061' from DER, 24' left of centerline, up to 1613' MSL.
 Trees beginning 2082' from DER, 272' right of centerline, up to 1565' MSL.
 Trees beginning 2121' from DER, 205' right of centerline, up to 1568' MSL.
 Tree 2222' from DER, 136' right of centerline, 1571' MSL.
 Trees beginning 2225' from DER, 143' right of centerline, up to 1577' MSL.
 Trees beginning 2269' from DER, 43' right of centerline, up to 1590' MSL.
 Trees beginning 2508' from DER, 94' right of centerline, up to 1598' MSL.
 Trees beginning 2550' from DER, 25' right of centerline, up to 1599' MSL.
 Trees beginning 2593' from DER, 38' right of centerline, up to 1601' MSL.
 Trees beginning 2601' from DER, 10' right of centerline, up to 1615' MSL.
 Tree, pole beginning 2609' from DER, 6' left of centerline, up to 1617' MSL.
 Trees beginning 2638' from DER, 141' right of centerline, up to 1622' MSL.
 Tree, transmission line beginning 2664' from DER, 2' right of centerline, up to 1624' MSL.
 Trees beginning 3441' from DER, 43' left of centerline, up to 1619' MSL.
 Trees beginning 3459' from DER, 72' left of centerline, up to 1625' MSL.
 Trees beginning 3581' from DER, 28' left of centerline, up to 1631' MSL.
 Trees beginning 3637' from DER, 1' left of centerline, up to 1635' MSL.
 Tree 5412' from DER, 508' right of centerline, 1630' MSL.
 Trees beginning 5491' from DER, 53' left of centerline, up to 1639' MSL.
 Trees beginning 5515' from DER, 13' right of centerline, up to 1636' MSL.
 Tree 5535' from DER, 36' right of centerline, 1639' MSL.
 Trees beginning 5600' from DER, 33' right of centerline, up to 1640' MSL.
 Trees beginning 5602' from DER, 47' left of centerline, up to 1641' MSL.
 Trees beginning 5616' from DER, 18' right of centerline, up to 1643' MSL.
 Trees beginning 5621' from DER, 11' left of centerline, up to 1643' MSL.
 Trees beginning 5632' from DER, 8' right of centerline, up to 1645' MSL.
 Trees beginning 5707' from DER, 11' left of centerline, up to 1645' MSL.

PAXTON, IL PAXTON (1C1) TAKEOFF MINIMUMS AND (OBSTACLE) DEPARTURE PROCEDURES AMDT 1 01JUL10 (10182) (FAA)

TAKEOFF MINIMUMS:

Rwy 36, 300-1½ or std. w/ min. climb of 321' per NM to 1200.

TAKEOFF OBSTACLE NOTES:

Rwy 36, vehicles on road 439' from DER, crossing from left to right, up to 15' AGL/796' MSL.
 Trees beginning 557' from DER, 31' right of centerline, up to 60' AGL/849' MSL.
 Tower 1.1 NM from DER, 1761' left of centerline, 179' AGL/983' MSL.

PEKIN, IL PEKIN MUNI (C15) TAKEOFF MINIMUMS AND (OBSTACLE) DEPARTURE PROCEDURES ORIG 25SEP08 (08269) (FAA)

TAKEOFF OBSTACLE NOTES:

Rwy 9, trees beginning 62' from DER, 411' right of centerline, up to 63' AGL/583' MSL.
 Poles beginning 819' from DER, 388' left of centerline, up to 32' AGL/552' MSL.
 Poles beginning 824' from DER, 411' right of centerline, up to 34' AGL/554' MSL.
Rwy 27, rising terrain 718' from DER, 103' left of centerline, up to 550' MSL.

TAKEOFF MINIMUMS, (OBSTACLE) DEPARTURE PROCEDURES, AND DIVERSE VECTOR AREA (RADAR VECTORS)

23278

EC-3

TAKEOFF MINIMUMS, (OBSTACLE) DEPARTURE PROCEDURES, AND DIVERSE VECTOR AREA (RADAR VECTORS)

23278

PEORIA, IL

GENERAL DOWNING - PEORIA INTL (PIA)

TAKEOFF MINIMUMS AND (OBSTACLE) DEPARTURE PROCEDURES

AMDT 2 30APR15 (15120) (FAA)

TAKEOFF OBSTACLE NOTES:

- Rwy 4**, trees beginning 1217' from DER, 548' left of centerline, up to 85' AGL/742' MSL.
Trees beginning 1389' from DER, 597' right of centerline, up to 75' AGL/728' MSL.
Tank 4757' from DER, 1617' left of centerline, 131' AGL/781' MSL.
- Rwy 13**, trees beginning 1020' from DER, 722' left of centerline, up to 85' AGL/705' MSL.
Trees 1175' from DER, 773' right of centerline, 60' AGL/682' MSL.
Flagpole 1748' from DER, 783' right of centerline, 53' AGL/687' MSL.
Trees beginning 3783' from DER, 1448' left of centerline, up to 85' AGL/747' MSL.
- Rwy 22**, trees beginning 450' from DER, 558' right of centerline, up to 60' AGL/691' MSL.
- Rwy 31**, trees beginning 818' from DER, 607' left of centerline, up to 50' AGL/706' MSL.
Trees beginning 1480' from DER, 690' right of centerline, up to 75' AGL/736' MSL.
Trees beginning 2000' from DER, 900' left of centerline, up to 75' AGL/760' MSL.
Trees beginning 3400' from DER, 165' right of centerline, up to 75' AGL/776' MSL.

MOUNT HAWLEY AUXILIARY (3MY)

TAKEOFF MINIMUMS AND (OBSTACLE) DEPARTURE PROCEDURES

AMDT 3 12DEC13 (13346) (FAA)

TAKEOFF OBSTACLE NOTES:

- Rwy 18**, trees beginning 369' from DER, 247' left of centerline, up to 100' AGL/826' MSL.
Trees beginning 537' from DER, 351' right of centerline, up to 100' AGL/853' MSL.
Building 714' from DER, 291' left of centerline, 30' AGL/809' MSL.
Building 1104' from DER, 225' left of centerline, 23' AGL/802 MSL.
Trees 1328' from DER, across centerline, up to 100' AGL/834 MSL.
- Rwy 36**, peak 100' from DER, 374' right of centerline, 20' AGL/809' MSL.
Trees beginning 506' from DER, 12' right of centerline, up to 100' AGL/899' MSL.
Trees beginning 810' from DER, 324' left of centerline, up to 100' AGL/909' MSL.
Trees and light poles beginning 946' from DER, 514' right of centerline, 46' AGL/845' MSL.
Vehicles on roadway 984' from DER, 420' left of centerline, 15' AGL/824' MSL.
Tower 2311' from DER, 655' left of centerline, 61' AGL/858' MSL.

PERU, IL

ILLINOIS VALLEY RGNL-WALTER A DUNCAN FLD (VYS)

TAKEOFF MINIMUMS AND (OBSTACLE) DEPARTURE PROCEDURES

AMDT 1 15OCT15 (21224) (FAA)

TAKEOFF MINIMUMS:

- Rwy 7**, 300-1 or std. w/min. climb of 285' per NM to 900.

DEPARTURE PROCEDURE:

- Rwy 18**, climb heading 198° to 1400 before turning left.

TAKEOFF OBSTACLE NOTES:

- Rwy 7**, numerous poles beginning 501' from DER, right and left of centerline, up to 65' AGL/704' MSL.
- Rwy 18**, bush 82' from DER, 266' right of centerline, 5' AGL/641' MSL.
Tree 1858' from DER, 803' left of centerline, 59' AGL/687' MSL.
- Rwy 25**, trees beginning 1176' from DER, right and left of centerline, up to 111' AGL/718' MSL.
- Rwy 36**, sign 1929' from DER, 936' right of centerline, 69' AGL/723' MSL.
Poles beginning 1070' from DER, crossing left and right of centerline up to 71' AGL/713' MSL.

PHILLIPS, WI

PRICE COUNTY (PBH)

TAKEOFF MINIMUMS AND (OBSTACLE) DEPARTURE PROCEDURES

AMDT 2 07DEC17 (17341) (FAA)

TAKEOFF MINIMUMS:

- Rwy 19**, 200-1 or std. w/min. climb of 272' per NM to 1700.

TAKEOFF OBSTACLE NOTES:

- Rwy 1**, trees beginning 61' from DER, 18' left of centerline, up to 1526' MSL.
Tree 121' from DER, 463' right of centerline, 1519' MSL.
Trees beginning 1027' from DER, 674' right of centerline, up to 1562' MSL.
Trees beginning 1606' from DER, 743' right of centerline, up to 1573' MSL.
Pole, trees beginning 1813' from DER, 905' right of centerline, up to 72' AGL/1583' MSL.
Tree 2544' from DER, 498' left of centerline, 1563' MSL.
Trees beginning 2595' from DER, 655' right of centerline, up to 1586' MSL.
Tree 2765' from DER, 104' left of centerline, 1567' MSL.
Trees beginning 2871' from DER, 26' right of centerline, up to 1592' MSL.
Tree 3056' from DER, 355' left of centerline, 1575' MSL.
Tree 3315' from DER, 75' left of centerline, 1580' MSL.
Tree 3374' from DER, 401' left of centerline, 1583' MSL.
Tree 3560' from DER, 345' right of centerline, 1594' MSL.
Tree 3617' from DER, 20' left of centerline, 1588' MSL.
Trees beginning 3725' from DER, 140' right of centerline, up to 1599' MSL.

CON'T

TAKEOFF MINIMUMS, (OBSTACLE) DEPARTURE PROCEDURES, AND DIVERSE VECTOR AREA (RADAR VECTORS)

23278

EC-3

TAKEOFF MINIMUMS, (OBSTACLE) DEPARTURE PROCEDURES, AND DIVERSE VECTOR AREA (RADAR VECTORS)

23278

PHILLIPS, WI (CON'T)

PRICE COUNTY (PBH) (CON'T)

Rwy 6, trees, terrain beginning 66' from DER, 97' right of centerline, up to 1516' MSL.
 Trees beginning 98' from DER, 240' left of centerline, up to 1518' MSL.
 Trees, terrain beginning 137' from DER, 159' left of centerline, up to 74' AGL/1523' MSL.
 Trees beginning 489' from DER, 296' left of centerline, up to 1533' MSL.
 Trees beginning 747' from DER, 45' left of centerline, up to 1537' MSL.
 Trees beginning 878' from DER, 382' right of centerline, up to 1518' MSL.
 Trees, building, water tower beginning 1189' from DER, 57' left of centerline, up to 1538' MSL.
 Tree 1294' from DER, 549' right of centerline, 1520' MSL.
 Trees beginning 1296' from DER, 549' right of centerline, up to 1525' MSL.
 Tree 1398' from DER, 507' right of centerline, 1530' MSL.
 Trees beginning 1430' from DER, 501' right of centerline, up to 1536' MSL.
 Tree 1522' from DER, 683' left of centerline, 1545' MSL.
 Trees beginning 1591' from DER, 489' right of centerline, up to 1540' MSL.
 Trees beginning 1601' from DER, 144' left of centerline, up to 82' AGL/1561' MSL.
 Trees, poles beginning 1717' from DER, 8' right of centerline, up to 1553' MSL.
 Trees, poles beginning 1895' from DER, 112' left of centerline, up to 1562' MSL.
 Trees, transmission lines beginning 2163' from DER, 42' left of centerline, up to 1563' MSL.
 Trees beginning 2239' from DER, 36' right of centerline, up to 1562' MSL.
 Tree 2353' from DER, 908' right of centerline, 1563' MSL.
 Trees beginning 2372' from DER, 7' right of centerline, up to 1574' MSL.
 Trees beginning 2373' from DER, 65' left of centerline, up to 1566' MSL.
 Trees beginning 2477' from DER, 54' left of centerline, up to 1567' MSL.
 Trees beginning 2523' from DER, 12' left of centerline, up to 1569' MSL.
 Trees beginning 2646' from DER, 129' left of centerline, up to 1572' MSL.
 Trees beginning 3779' from DER, 17' left of centerline, up to 1577' MSL.
 Tree 3980' from DER, 79' right of centerline, 1575' MSL.
 Trees beginning 4095' from DER, 182' left of centerline, up to 1580' MSL.
 Trees beginning 4118' from DER, 56' left of centerline, up to 1587' MSL.
 Trees beginning 4289' from DER, 191' left of centerline, up to 1595' MSL.
 Tree 4291' from DER, 143' right of centerline, 1592' MSL.
 Trees beginning 4292' from DER, 11' right of centerline, up to 85' AGL/1594' MSL.
Rwy 19, tree 61' from DER, 452' left of centerline, 1501' MSL.
 Trees beginning 1110' from DER, 609' left of centerline, up to 1527' MSL.
 Trees beginning 1164' from DER, 654' left of centerline, up to 1530' MSL.
 Trees beginning 1309' from DER, 10' left of centerline, up to 1531' MSL.
 Tree 1441' from DER, 624' right of centerline, 1506' MSL.
 Tree 1463' from DER, 591' right of centerline, 45' AGL/1508' MSL.
 Trees beginning 1558' from DER, 418' right of centerline, up to 1515' MSL.
 Trees beginning 1999' from DER, 78' right of centerline, up to 1523' MSL.
 Trees beginning 3874' from DER, 941' right of centerline, up to 1576' MSL.
 Tank 4854' from DER, 1681' left of centerline, 144' AGL/1624' MSL.
 Water tower 4890' from DER, 1744' left of centerline, 148' AGL/1631' MSL.
Rwy 24, building 38' from DER, 478' right of centerline, 1489' MSL.
 Buildings beginning 48' from DER, 454' left of centerline, up to 24' AGL/1489' MSL.
 Antenna 97' from DER, 397' right of centerline, 35' AGL/1499' MSL.
 Poles beginning 198' from DER, 352' right of centerline, up to 36' AGL/1500' MSL.
 Pole 217' from DER, 420' left of centerline, 35' AGL/1500' MSL.
 Trees, fence beginning 291' from DER, 91' left of centerline, up to 52' AGL/1516' MSL.
 Poles beginning 643' from DER, 455' right of centerline, up to 51' AGL/1512' MSL.
 Trees, pole beginning 976' from DER, 283' left of centerline, up to 77' AGL/1537' MSL.
 Trees, pole beginning 1162' from DER, 580' right of centerline, up to 1525' MSL.
 Trees beginning 1427' from DER, 495' right of centerline, up to 1534' MSL.
 Trees beginning 1672' from DER, 504' right of centerline, up to 1541' MSL.
 Trees beginning 1738' from DER, 405' left of centerline, up to 1548' MSL.
 Trees beginning 1823' from DER, 517' right of centerline, up to 1542' MSL.
 Trees beginning 1964' from DER, 512' right of centerline, up to 1553' MSL.

PINCKNEYVILLE, IL

PINCKNEYVILLE/DU QUOIN (PJY)

TAKEOFF MINIMUMS AND (OBSTACLE) DEPARTURE PROCEDURES

ORIG 22SEP11 (22027) (FAA)

TAKEOFF OBSTACLE NOTES:

Rwy 18, vehicle on road beginning at DER, 340' left of centerline, 15' AGL/409' MSL.
 Power lines and vehicle on road beginning 507' from DER, left and right of centerline, up to 40' AGL/434' MSL.
Rwy 36, trees beginning 1740' from DER, 724' right of centerline, up to 100' AGL/495' MSL.

22 FEB 2024 to 21 MAR 2024

22 FEB 2024 to 21 MAR 2024

TAKEOFF MINIMUMS, (OBSTACLE) DEPARTURE PROCEDURES, AND DIVERSE VECTOR AREA (RADAR VECTORS)

23278

EC-3

TAKEOFF MINIMUMS, (OBSTACLE) DEPARTURE PROCEDURES, AND DIVERSE VECTOR AREA (RADAR VECTORS)

23278

PITTSFIELD, IL

PITTSFIELD PENSTONE MUNI (PPQ)

TAKEOFF MINIMUMS AND (OBSTACLE) DEPARTURE PROCEDURES

ORIG 26JUL12 (12208) (FAA)

TAKEOFF OBSTACLE NOTES:

Rwy 13, vehicles on roadway beginning 27' from DER, 360' right of centerline, up to 15' AGL/724' MSL.

Trees beginning 819' from DER, 564' right of centerline, up to 100' AGL/779' MSL.

Trees beginning 912' from DER, 629' left of centerline, up to 100' AGL/759' MSL.

Trees beginning 3602' from DER, 627' right of centerline, up to 100' AGL/789' MSL.

Rwy 31, trees beginning 594' from DER, 626' left of centerline, up to 100' AGL/789' MSL.

Vehicles on roadway beginning 1038' from DER, 776' right of centerline, up to 17' AGL/746' MSL.

Trees beginning 1652' from DER, 172' right of centerline, up to 100' AGL/789' MSL.

Trees beginning 5157' from DER, 1284' right of centerline, up to 100' AGL/859' MSL.

PLATTEVILLE, WI

PLATTEVILLE MUNI (PVB)

TAKEOFF MINIMUMS AND (OBSTACLE) DEPARTURE PROCEDURES

ORIG 27AUG09 (09239) (FAA)

TAKEOFF OBSTACLE NOTES:

Rwy 7, vehicle on road beginning 499' from DER, left to right of centerline, up to 15' AGL/1053' MSL.

Pavilion 250' from DER, 345' left of centerline, 17' AGL/1039' MSL.

Poles beginning 208' from DER, 438' left of centerline, up to 37' AGL/1059' MSL.

Trees beginning 224' from DER, 17' right of centerline, up to 47' AGL/1069' MSL.

Trees beginning 257' from DER, 222' left of centerline, up to 29' AGL/1051' MSL.

Rwy 25, tree 91' from DER, 277' left of centerline, 21' AGL/1020' MSL.

Trees beginning 57' from DER, 325' right of centerline, up to 10' AGL/1009' MSL.

Rwy 15, tree 1145' from DER, 620' right of centerline, 52' AGL/1073' MSL.

Trees beginning 61' from DER, 208' left of centerline, up to 11' AGL/1032' MSL.

PONTIAC, IL

PONTIAC MUNI (PNT)

TAKEOFF MINIMUMS AND (OBSTACLE) DEPARTURE PROCEDURES

ORIG 31JUL08 (08213) (FAA)

TAKEOFF OBSTACLE NOTES:

Rwy 24, multiple buildings beginning 766' from DER, 60' left of centerline, up to 28' AGL/672' MSL.

Tree 2226' from DER, 1040' right of centerline, 100' AGL/744' MSL.

Multiple light poles beginning 3635' from DER, 262' right of centerline, up to 130' AGL/774' MSL.

POPLAR GROVE, IL

POPLAR GROVE (C77)

TAKEOFF MINIMUMS AND (OBSTACLE) DEPARTURE PROCEDURES

ORIG 04NOV99 (99308) (FAA)

TAKEOFF MINIMUMS:

Rwy 30, 300-1 or std. with a min. climb of 310' per NM to 1000.

Rwys 9, 12, 17, 27, 35, NA.

PORTAGE, WI

PORTAGE MUNI (C47)

TAKEOFF MINIMUMS AND (OBSTACLE) DEPARTURE PROCEDURES

AMDT 2 05JAN17 (17005) (FAA)

TAKEOFF MINIMUMS:

Rwy 22, std. w/min. climb of 259' per NM to 1900 or 1000-2½ for VCOA.

DEPARTURE PROCEDURE:

Rwy 18, climb on heading 181° to 1900 before turning right.

VCOA:

Rwy 22, obtain ATC approval for VCOA when requesting IFR clearance. Climb in visual conditions to cross Portage Muni airport at or above 1700 before proceeding on course.

TAKEOFF OBSTACLE NOTES:

Rwy 4, trees and vehicles on road beginning at DER, 48' right of centerline, up to 100' AGL/925' MSL.

Vehicles on road 1' from DER, 88' left of centerline, 15' AGL/840' MSL.

Trees beginning 12' from DER, 27' left of centerline, up to 100' AGL/925' MSL.

Trees and telephone line beginning 120' from DER, 264' left of centerline, up to 43' AGL/852' MSL.

Trees beginning 1573' from DER, 551' left of centerline, up to 77' AGL/906' MSL.

Rwy 18, trees and poles 5' from DER, 127' right of centerline, up to 42' AGL/860' MSL.

Vehicle on road 64' from DER, 22' right of centerline, 15' AGL/835' MSL.

Parking lots 222' from DER, 134' right of centerline, 837' MSL.

Tree and parking lot beginning 336' from DER, 91' right of centerline, up to 874' MSL.

Tree 373' from DER, 215' right of centerline, 888' MSL.

Tree, parking lot, pole, bldg, telephone line and fence beginning 449' from DER, 19' right of centerline, up to 889' MSL.

Tree 1008' from DER, 437' right of centerline, 895' MSL.

Power transmission lines, tree, vehicles on road beginning 1072' from DER, 2' right of centerline, up to 77' AGL/906' MSL.

CON'T

TAKEOFF MINIMUMS, (OBSTACLE) DEPARTURE PROCEDURES, AND DIVERSE VECTOR AREA (RADAR VECTORS)

23278

EC-3

TAKEOFF MINIMUMS, (OBSTACLE) DEPARTURE PROCEDURES, AND DIVERSE VECTOR AREA (RADAR VECTORS)

23278

PORTAGE, WI (CON'T)

PORTAGE MUNI (C47) (CON'T)

Rwy 18 (CON'T), power transmission lines, vehicle on road, tree and pole beginning 1277' from DER, 43' right of centerline, up to 103' AGL/940' MSL.

Pole beginning 47' from DER, 187' left of centerline, up to 26' AGL/848' MSL.

Telephone line, pole and vehicle on road beginning 57' from DER, 81' left of centerline, up to 853' MSL.

Tree 271' from DER, 148' left of centerline, 858' MSL.

Tree and vehicle on road beginning 372' from DER, 135' left of centerline, up to 865' MSL.

Tree 483' from DER, 621' left of centerline, 869' MSL.

Tree and bldg beginning 529' from DER, 66' left of centerline, up to 880' MSL.

Tree 600' from DER, 343' left of centerline, 882' MSL.

Trees beginning 622' from DER, 453' left of centerline, up to 888' MSL.

Tree, pole and telephone line beginning 700' from DER, 150' left of centerline, up to 892' MSL.

Tree and power transmission lines beginning 905' from DER, 3' left of centerline, up to 902' MSL.

Tree 1870' from DER, 111' left of centerline, 907' MSL.

Tree, pole and power transmission lines beginning 1996' from DER, 1' left of centerline, up to 921' MSL.

Power transmission lines and tree beginning 3392' from DER, 222' left of centerline, up to 925' MSL.

Rwy 22, trees beginning at DER, 107' right of centerline, up to 100' AGL/925' MSL.

Parking lot 69' from DER, 222' right of centerline, 840' MSL.

Vehicles on road beginning 377' from DER, 9' right of centerline, up to 15' AGL/840' MSL.

Pole 403' from DER, 352' right of centerline, 63' AGL/886' MSL.

Power transmission lines beginning 1000' from DER, 412' right of centerline, up to 64' AGL/886' MSL.

Power transmission lines beginning 1833' from DER, 114' right of centerline, up to 899' MSL.

Power transmission lines beginning 2295' from DER, 1054' right of centerline, up to 955' MSL.

Bldg 7' from DER, 313' left of centerline, 33' AGL/856' MSL.

Ol on bldg and parking lot beginning 14' from DER, 243' left of centerline, up to 859' MSL.

Trees beginning 221' from DER, 68' left of centerline, up to 862' MSL.

Tree, vehicles on road, pole and telephone line beginning 267' from DER, 44' left of centerline, up to 873' MSL.

Tree 443' from DER, 245' left of centerline, 56' AGL/879' MSL.

Tree, telephone line, pole, bldg and sign beginning 507' from DER, 137' left of centerline, up to 890' MSL.

Power transmission lines beginning 1344' from DER, 830' left of centerline, up to 891' MSL.

Power transmission lines beginning 1595' from DER, 562' left of centerline, up to 901' MSL.

Trees beginning 2046' from DER, 183' left of centerline, up to 917' MSL.

Tree 2542' from DER, 636' left of centerline, 923' MSL.

Tree 2625' from DER, 1179' left of centerline, 925' MSL.

Rwy 36, trees beginning 2' from DER, 43' right of centerline, up to 51' AGL/847' MSL.

Tree and vehicles on road beginning 46' from DER, 28' right of centerline, up to 882' MSL.

Trees beginning 1633' from DER, 13' right of centerline, up to 883' MSL.

Trees beginning 2673' from DER, 407' right of centerline, up to 110' AGL/903' MSL.

Vehicles on road beginning 13' from DER, 116' left of centerline, up to 821' MSL.

Tree and vehicles on road beginning 105' from DER, 50' left of centerline, up to 827' MSL.

Trees beginning 365' from DER, 224' left of centerline, up to 831' MSL.

Tree 450' from DER, 126' left of centerline, 832' MSL.

Tree 621' from DER, 128' left of centerline, 853' MSL.

Trees beginning 707' from DER, 130' left of centerline, up to 875' MSL.

Trees beginning 997' from DER, 11' left of centerline, up to 880' MSL.

Tree 3079' from DER, 366' left of centerline, 893' MSL.

Trees beginning 3167' from DER, 284' left of centerline, up to 903' MSL.

PRAIRIE DU CHIEN, WI

PRAIRIE DU CHIEN MUNI (PDC)

TAKEOFF MINIMUMS AND (OBSTACLE) DEPARTURE PROCEDURES

AMDT 4 26JUL12 (12208) (FAA)

TAKEOFF MINIMUMS:

Rwy 11, 200-1¼ or std. w/min. climb of 444' per NM to 900.

Rwy 14, 600-3 w/min. climb of 251' per NM to 1400 or std. w/min. climb of 589' per NM to 1400, or 1200-2½ for climb in visual conditions.

Rwy 29, 500-3 w/min. climb of 230' per NM to 1300 or std. w/min. climb of 261' per NM to 1300, or 1200-2½ for climb in visual conditions.

DEPARTURE PROCEDURE:

Rwy 11, climb heading 110° to 2000 before turning.

Rwy 14, climb heading 140° to 2000 before turning, for climb in visual conditions cross Prairie du Chien airport at or above 1700' MSL before proceeding on course. When executing VCOA, notify ATC prior to departure.

Rwy 29, climb heading 290° to 2000 before turning, for climb in visual conditions cross Prairie du Chien airport at or above 1700' MSL before proceeding on course. When executing VCOA, notify ATC prior to departure.

Rwy 32, climb heading 320° to 2000 before turning.

TAKEOFF OBSTACLE NOTES:

Rwy 11, poles, signs, trees, terrain and road beginning 59' from DER, 9' left of centerline, up to 70' AGL/809' MSL.

Trees beginning 966' from DER, 7' right of centerline, up to 111' AGL/810' MSL.

Rwy 14, trees, terrain, and NAVAID beginning 21' from DER, 62' left of centerline, up to 187' AGL/801' MSL.

Trees and railroad beginning 180' from DER, 53' right of centerline, up to 112' AGL/727' MSL.

Rwy 29, tanks, railroad, trees, and road beginning 141' from DER, 11' left of centerline, up to 70' AGL/724' MSL.

Trees, poles, road, and tower beginning 446' from DER, 89' right of centerline, up to 68' AGL/717' MSL.

CON'T

TAKEOFF MINIMUMS, (OBSTACLE) DEPARTURE PROCEDURES, AND DIVERSE VECTOR AREA (RADAR VECTORS)

23278

EC-3

TAKEOFF MINIMUMS, (OBSTACLE) DEPARTURE PROCEDURES, AND DIVERSE VECTOR AREA (RADAR VECTORS)

23278

PRAIRIE DU CHIEN, WI (CON'T)

PRAIRIE DU CHIEN MUNI (PDC) (CON'T)

Rwy 32, NAVAIDs 25' from DER, 77' left and right of centerline, up to 4' AGL/653' MSL.

Pole 2410' from DER, 198' left of centerline, 60' AGL/714' MSL.

Trees, poles, and towers beginning 1418' from DER, 200' right of centerline, up to 65' AGL/719' MSL.

PRAIRIE DU SAC, WI

SAUK/PRAIRIE (91C)

TAKEOFF MINIMUMS AND (OBSTACLE) DEPARTURE PROCEDURES

ORIG 20DEC07 (21336) (FAA)

TAKEOFF MINIMUMS:

Rwy 36, std. w/min. climb gradient of 221' per NM to 1700 or 1000-3 for climb in visual conditions.

DEPARTURE PROCEDURE:

Rwy 36, climb heading 357° to 1700 before turning or for climb in visual conditions cross Sauk/Prairie airport at or above 1700 MSL before proceeding on course.

TAKEOFF OBSTACLE NOTES:

Rwy 18, utility pole, 330' from DER, 325' right of centerline, 19' AGL/839' MSL.

Trees beginning 802' from DER, 175' left of centerline, up to 100' AGL/919' MSL.

Trees beginning 921' from DER, on centerline, up to 100' AGL/929' MSL.

Rwy 36, navigation light top 15' from DER, 35' right of centerline, 2' AGL/833' MSL.

Navigation light top 16' from DER, 60' left of centerline, 3' AGL/834' MSL.

Silo top 855' from DER, 414' left of centerline, up to 33' AGL/864' MSL.

Trees beginning 967' from DER, 611' left of centerline, up to 60' AGL/891' MSL.

QUINCY, IL

QUINCY RGNL-BALDWIN FLD (IUN)

TAKEOFF MINIMUMS AND (OBSTACLE) DEPARTURE PROCEDURES

ORIG-A 15JUN23 (23166) (FAA)

TAKEOFF OBSTACLE NOTES:

Rwy 4, terrain 352' from DER, 400' right of centerline, 784' MSL.

Tree 1041' from DER, 706' right of centerline, 797' MSL.

Tree 1128' from DER, 623' left of centerline, 775' MSL.

Rwy 22, tree 620' from DER, 665' right of centerline, 804' MSL.

RACINE, WI

BATTEN INTL (RAC)

TAKEOFF MINIMUMS AND (OBSTACLE) DEPARTURE PROCEDURES

AMDT 5A 22JUN17 (17173) (FAA)

TAKEOFF OBSTACLE NOTES:

Rwy 4, trees beginning 137' from DER, 185' right of centerline, up to 676' MSL.

Tree 195' from DER, 445' left of centerline, 690' MSL.

Pole beginning 220' from DER, 530' left of centerline, up to 692' MSL.

Tree, pole, building beginning 223' from DER, 226' left of centerline, up to 694' MSL.

Tree 394' from DER, 96' right of centerline, 681' MSL.

Tree 576' from DER, 521' left of centerline, 701' MSL.

Trees beginning 620' from DER, 205' left of centerline, up to 702' MSL.

Pole beginning 688' from DER, 419' right of centerline, up to 697' MSL.

Tree, pole beginning 692' from DER, 280' left of centerline, up to 709' MSL.

Tree 1371' from DER, 500' left of centerline, 712' MSL.

Rwy 14, tree 18' from DER, 497' right of centerline, 673' MSL.

Tree 19' from DER, 314' left of centerline, 702' MSL.

Trees beginning 71' from DER, 315' right of centerline, up to 716' MSL.

Tower, ant, pole, flgpl, tree beginning 239' from DER, 431' left of centerline, up to 57' AGL/706' MSL.

OL on light stan, pole, tree beginning 361' from DER, 2' right of centerline, up to 717' MSL.

Tree, tower, ant, antenna beginning 617' from DER, 181' left of centerline, up to 711' MSL.

Trees beginning 1940' from DER, 695' right of centerline, up to 718' MSL.

Rwy 22, pole, light standard, vehicle on road beginning 35' from DER, 1' left of centerline, up to 22' AGL/694' MSL.

Tree 253' from DER, 177' left of centerline, 701' MSL.

Tree 1450' from DER, 168' left of centerline, 713' MSL.

Tree 1521' from DER, 37' right of centerline, 723' MSL.

Tree 1628' from DER, 614' right of centerline, 729' MSL.

Tree 2927' from DER, 546' right of centerline, 749' MSL.

Tree 3120' from DER, 274' right of centerline, 763' MSL.

Tower, antenna beginning 3843' from DER, 1214' right of centerline, up to 103' AGL/797' MSL.

Rwy 32, fence, blast fence beginning 18' from DER, 103' left of centerline, up to 8' AGL/682' MSL.

Building beginning 63' from DER, 484' left of centerline, up to 686' MSL.

Tree, vehicle on road, tower, building beginning 79' from DER, 66' left of centerline, up to 57' AGL/734' MSL.

Vehicle on road 180' from DER, 17' right of centerline, 688' MSL.

Pole, OL on pole beginning 215' from DER, 116' right of centerline, up to 28' AGL/698' MSL.

Tree, vehicle on road beginning 238' from DER, 9' right of centerline, up to 722' MSL.

Trees beginning 357' from DER, 94' right of centerline, up to 732' MSL.

Tower, antenna, tree, pole beginning 395' from DER, 153' left of centerline, up to 56' AGL/736' MSL.

CON'T

TAKEOFF MINIMUMS, (OBSTACLE) DEPARTURE PROCEDURES, AND DIVERSE VECTOR AREA (RADAR VECTORS)

23278

EC-3

TAKEOFF MINIMUMS, (OBSTACLE) DEPARTURE PROCEDURES, AND DIVERSE VECTOR AREA (RADAR VECTORS)

23278

RACINE, WI (CON'T)

BATTEN INTL (RAC) (CON'T)

Rwy 32 (CON'T), trees beginning 420' from DER, 13' right of centerline, up to 740' MSL.
Trees beginning 584' from DER, 260' left of centerline, up to 739' MSL.
Tree 839' from DER, 491' left of centerline, 742' MSL.
Tree 842' from DER, 391' left of centerline, 751' MSL.
Trees beginning 944' from DER, 56' left of centerline, up to 80' AGL/759' MSL.

RANTOUL, IL

RANTOUL NTL AVN CNTR-FRANK ELLIOTT FLD (TIP)

TAKEOFF MINIMUMS AND (OBSTACLE) DEPARTURE PROCEDURES

AMDT 1 15DEC11 (21224) (FAA)

TAKEOFF OBSTACLE NOTES:

Rwy 9, trees beginning 1994' from DER, 28' right of centerline, up to 100' AGL/829' MSL.
Rwy 18, trees beginning 1285' from DER, 12' left of centerline, up to 100' AGL/839' MSL.
Rwy 27, trees beginning 2651' from DER, 15' right of centerline, up to 100' AGL/839' MSL.
Rwy 36, trees beginning 1313' from DER, 5' right of centerline, up to 100' AGL/839' MSL.
Tower 4949' from DER, 1784' right of centerline, 139' AGL/874' MSL.

REEDSBURG, WI

REEDSBURG MUNI (C35)

TAKEOFF MINIMUMS AND (OBSTACLE) DEPARTURE PROCEDURES

AMDT 2A 14JUL22 (22195) (FAA)

TAKEOFF MINIMUMS:

Rwys 7, 25, NA-Obstacles.

Rwy 18, std. w/min. climb of 505' per NM to 1400 or 400-1¼ w/min. climb of 215' per NM to 2000 or 1000-3. For climb in visual conditions.

Rwy 36, 400-2 or std. w/min. climb of 300' per NM to 1400.

DEPARTURE PROCEDURE:

Rwy 18, for climb in visual conditions: cross Reedsburg Muni airport at or above 1600 MSL before proceeding on course. When executing VCOA, notify ATC prior to departure.

TAKEOFF OBSTACLE NOTES:

Rwy 18, trees beginning 22' from DER, 6' right of centerline, up to 88' AGL/1031' MSL.
Train and railroad tracks 99' from DER, right to left of centerline, 23' AGL/900' MSL.
Terrain beginning 286' from DER, 83' right of centerline, 1033' MSL.
Vehicles on road 571' from DER, right to left of centerline, 15' AGL/1033' MSL.
T-L tower 3633' from DER, right to left of centerline, up to 80' AGL/1009' MSL.
Trees beginning 27' from DER, 6' left of centerline, up to 89' AGL/1032' MSL.
Pole 3842' from DER, 39' left of centerline, up to 76' AGL/997' MSL.
Terrain beginning 5518' from DER, 14' left of centerline, 1033' MSL.
Rwy 36, vertical structures beginning 23' from DER, 62' right and left of centerline, up to 21' AGL/942' MSL.
Vehicle on road 44' from DER, left to right of centerline, 15' AGL/962' MSL.
Buildings beginning 79' from DER, 5' right of centerline, up to 29' AGL/1050' MSL.
Trees beginning 100' from DER, 12' right of centerline, up to 40' AGL/1041' MSL.
Fences beginning 121' from DER, right and left of centerline, up to 24' AGL/925' MSL.
Signs beginning 196' from DER, left and right of centerline, up to 38' AGL/939' MSL.
Parking lot 198' from DER, 295' right of centerline, 13' AGL/914' MSL.
Poles beginning 204' from DER, right and left of centerline, up to 102' AGL/1043' MSL.
Light support structures beginning 291' from DER, left and right of centerline, up to 44' AGL/945' MSL.
Buildings beginning 328' from DER, 107' left of centerline, up to 55' AGL/976' MSL.
Terrain beginning 397' from DER, 176' right of centerline, up to 915' MSL.
Flag poles 825' from DER, 158' left of centerline, up to 37' AGL/978' MSL.
Trees and transmission line beginning 1032' from DER, 28' left of centerline, up to up to 61' AGL/1041' MSL.

RHINELANDER, WI

RHINELANDER/ONEIDA COUNTY (RHI)

TAKEOFF MINIMUMS AND (OBSTACLE) DEPARTURE PROCEDURES

AMDT 4B 05NOV20 (21336) (FAA)

TAKEOFF MINIMUMS:

Rwy 9, std. w/min. climb of 230' per NM to 3900, or 1100-3 for VCOA.

DEPARTURE PROCEDURE:

Rwy 9, climb on heading 091° to 3900 before turning.

VCOA:

Rwy 9, obtain ATC approval for VCOA when requesting IFR clearance. Climb in visual conditions to cross Rhinelander/Oneida County airport at or above 2600 before proceeding on course.

TAKEOFF OBSTACLE NOTES:

Rwy 9, utility pole 40' from DER, 149' right of centerline, 1' AGL/1601' MSL.
Utility pole 41' from DER, 149' left of centerline, 1' AGL/1601' MSL.
Trees beginning 2294' from DER, 977' right of centerline, up to 1670' MSL.
Tree 2769' from DER, 931' left of centerline, 1669' MSL.
Trees beginning 2870' from DER, 910' left of centerline, up to 1678' MSL.
Tree 3006' from DER, 1092' right of centerline, 1675' MSL.

CON'T

TAKEOFF MINIMUMS, (OBSTACLE) DEPARTURE PROCEDURES, AND DIVERSE VECTOR AREA (RADAR VECTORS)

23278

EC-3

TAKEOFF MINIMUMS, (OBSTACLE) DEPARTURE PROCEDURES, AND DIVERSE VECTOR AREA (RADAR VECTORS)

23278

RACINE, WI (CON'T)

BATTEN INTL (RAC) (CON'T)

- Rwy 9 (CON'T)**, tree 3010' from DER, 1283' left of centerline, 1679' MSL.
 Tree 3054' from DER, 1196' right of centerline, 1680' MSL.
 Trees beginning 3106' from DER, 1076' right of centerline, up to 1684' MSL.
 Trees beginning 3110' from DER, 1104' left of centerline, up to 1689' MSL.
 Trees beginning 3218' from DER, 710' left of centerline, up to 1690' MSL.
 Stack 1.6 NM from DER, 3028' left of centerline, 296' AGL/1857' MSL.
Rwy 15, fence beginning 61' from DER, 482' left of centerline, up to 6' AGL/1625' MSL.
 Trees and pole beginning 624' from DER, 283' right of centerline, up to 1684' MSL.
 Trees beginning 663' from DER, 465' left of centerline, up to 1657' MSL.
 Trees beginning 681' from DER, 376' left of centerline, up to 1660' MSL.
Rwy 27, vehicle on road beginning 99' from DER, 50' left of centerline, up to 1638' MSL.
 Vehicle on road 620' from DER, 611' right of centerline, 1651' MSL.
 Fence 763' from DER, 642' right of centerline, 14' AGL/1252' MSL.
 Vehicle on road beginning 884' from DER, 648' right of centerline, up to 1655' MSL.
 Vehicle on road 1206' from DER, 695' right of centerline, 1660' MSL.
 Tree 2686' from DER, 1147' right of centerline, 1691' MSL.
 Tree 2890' from DER, 1190' right of centerline, 1696' MSL.
Rwy 33, tree 187' from DER, 405' left of centerline, 1609' MSL.
 Tree 355' from DER, 347' left of centerline, 1631' MSL.
 Tree and poles beginning 704' from DER, 405' left of centerline, up to 1655' MSL.
 Tree 891' from DER, 527' right of centerline, 1659' MSL.
 Tree 1267' from DER, 831' right of centerline, 1685' MSL.
 Tree 1559' from DER, 615' left of centerline, 1658' MSL.
 Tree 1650' from DER, 450' right of centerline, 1686' MSL.
 Tree 1693' from DER, 426' right of centerline, 1690' MSL.
 Tree 1724' from DER, 750' right of centerline, 1703' MSL.
 Trees and pole beginning 1770' from DER, 338' right of centerline, up to 1704' MSL.
 Pole 1803' from DER, 335' left of centerline, 1664' MSL.
 Pole 2135' from DER, 106' left of centerline, 1669' MSL.
 Trees beginning 2190' from DER, 150' left of centerline, up to 1678' MSL.
 Trees and pole beginning 3018' from DER, 299' right of centerline, up to 1706' MSL.
 Trees beginning 3183' from DER, 234' right of centerline, up to 1709' MSL.

RICE LAKE, WI

RICE LAKE RGNL/CARL'S FLD (RPD)

TAKEOFF MINIMUMS AND (OBSTACLE) DEPARTURE PROCEDURES

ORIG-A 08NOV18 (21336) (FAA)

TAKEOFF MINIMUMS:

Rwy 1, std. w/min. climb of 231' per NM to 2200, or 1200-3 for climb in visual conditions.

DEPARTURE PROCEDURE:

Rwy 1, for climb in visual conditions: cross Rice Lake Rgnl/Carl's Fld at or above 2300.

Rwy 31, climb via heading 310° to 1900 before turning left.

TAKEOFF OBSTACLE NOTES:

Rwy 1, trees beginning 1324' from DER, 701' left of centerline, up to 1157' MSL.

Trees beginning 1703' from DER, 669' left of centerline, up to 1158' MSL.

Tree 1881' from DER, 970' left of centerline, 1162' MSL.

Tree 1971' from DER, 883' left of centerline, 1163' MSL.

Tree 2288' from DER, 893' left of centerline, 1167' MSL.

Rwy 13, trees 1550' from DER, 200' right of centerline, 67' AGL/1167' MSL.

Rwy 19, trees 2780' from DER, 200' left of centerline, 73' AGL/1169' MSL.

Rwy 31, trees 1480' from DER, 50' right of centerline, 64' AGL/1156' MSL.

RICHLAND CENTER, WI

RICHLAND (93C)

TAKEOFF MINIMUMS AND (OBSTACLE) DEPARTURE PROCEDURES

AMDT 1A 29AUG07 (07241) (FAA)

TAKEOFF MINIMUMS:

Rwys 9,17, NA.

Rwy 27, 400-2 or std. with a min. climb of 491' per NM to 1300.

Rwy 35, 300-1 or std. with a min. climb of 222' per NM to 1800.

TAKEOFF MINIMUMS, (OBSTACLE) DEPARTURE PROCEDURES, AND DIVERSE VECTOR AREA (RADAR VECTORS)

23278

EC-3

**TAKEOFF MINIMUMS, (OBSTACLE) DEPARTURE PROCEDURES, AND
DIVERSE VECTOR AREA (RADAR VECTORS)**

23278

ROBINSON, IL**CRAWFORD COUNTY (RSV)****TAKEOFF MINIMUMS AND (OBSTACLE) DEPARTURE PROCEDURES**

ORIG 25SEP08 (21224) (FAA)

TAKEOFF OBSTACLE NOTES:**Rwy 9**, trees 2285' from DER, 474' right of centerline, 60' AGL/516' MSL.

Trees 971' from DER, 594' left of centerline, 58' AGL/517' MSL.

Rwy 17, tree 2493' from DER, 521' right of centerline, 100' AGL/589' MSL.**Rwy 27**, trees beginning at 178' from DER, 358' right of centerline, up to 78' AGL/547' MSL.

Trees beginning at 2190' from DER, 89' left of centerline, 98' AGL/567' MSL.

Rwy 35, road with vehicle 693' from DER, 611' right of centerline, 15' AGL/474' MSL.

Tree 1545' from DER, 841' left of centerline, 100' AGL/554' MSL.

ROCHELLE, IL**ROCHELLE MUNI/KORITZ FLD (RPJ)****TAKEOFF MINIMUMS AND (OBSTACLE) DEPARTURE PROCEDURES**

AMDT 4 04FEB16 (21224) (FAA)

TAKEOFF MINIMUMS:**Rwy 7**, 300-1 w/min. climb of 243' per NM to 1700 or std. w/min. climb of 364' per NM to 1200.**TAKEOFF OBSTACLE NOTES:****Rwy 7**, runway lights and NAVAIDs beginning 10' from DER, 17' left and right of centerline, up to 3' AGL/782' MSL.

Fence 184' from DER, 427' right of centerline, 6' AGL/787' MSL.

Tree 292' from DER, 482' right of centerline, 64' AGL/845' MSL.

Trees and transmission line towers beginning 505' from DER, 375' right of centerline, up to 72' AGL/853' MSL.

Vehicle on road 695' from DER, 244' right of centerline, 15' AGL/799' MSL.

Transmission line towers beginning 1056' from DER, 425' left of centerline, up to 39' AGL/814' MSL.

Tower 3413' from DER, 1135' right of centerline, 120' AGL/924' MSL.

Elevator 3540' from DER, 953' right of centerline, 135' AGL/943' MSL.

Rwy 25, bush 108' from DER, 465' left of centerline, 6' AGL/778' MSL.

Road sign 152' from DER, 532' right of centerline, 22' AGL/794' MSL.

Tree 1625' from DER, 805' right of centerline, 61' AGL/831' MSL.

SALEM, IL**SALEM-LECKRONE (SLO)****TAKEOFF MINIMUMS AND (OBSTACLE) DEPARTURE PROCEDURES**

AMDT 7 10JAN13 (13010) (FAA)

TAKEOFF MINIMUMS:**Rwy 18**, 300-1¼ or std. w/min. climb of 291' per NM to 900' MSL.**DEPARTURE PROCEDURE:****Rwy 18**, Climb heading 181° to 1900 before turning east.**TAKEOFF OBSTACLE NOTES:****Rwy 18**, trees beginning 272' from DER, left and right of centerline, up to 100' AGL/635' MSL.

Antenna tower 1.0 NM from DER, 257' right of centerline, 200' AGL/739' MSL.

Tower 1.0 NM from DER, 126' left of centerline, 188' AGL/724' MSL.

Rwy 36, trees beginning 59' from DER, 249' right of centerline, up to 20' AGL/588' MSL.**SAVANNA, IL****TRI-TOWNSHIP (SFY)****TAKEOFF MINIMUMS AND (OBSTACLE) DEPARTURE PROCEDURES**

ORIG-A 12AUG21 (21224) (FAA)

TAKEOFF MINIMUMS:**Rwy 13**, 400-2¼ or std. w/min. climb of 208' per NM to 1100.**TAKEOFF OBSTACLE NOTES:****Rwy 13**, vehicle on road 20' from DER, 352' left of centerline, 627' MSL.

Tree 99' from DER, 71' right of centerline, 616' MSL.

Tree 104' from DER, 281' left of centerline, 635' MSL.

Trees, vehicle on road, agriculture equipment beginning 199' from DER, 25' left of centerline, up to 638' MSL.

Tree 278' from DER, 346' right of centerline, 627' MSL.

Tree 454' from DER, 0' of centerline, 628' MSL.

Tree 651' from DER, 40' right of centerline, 630' MSL.

Tree 720' from DER, 152' right of centerline, 631' MSL.

Tree 2.1 NM from DER, 3451' left of centerline, 947' MSL.

Rwy 31, vehicle on road 7' from DER, 421' right of centerline, 622' MSL.

Vehicle on road beginning 10' from DER, 168' right of centerline, up to 627' MSL.

Trees, vehicle on road beginning 132' from DER, 114' left of centerline, up to 638' MSL.

Tree 173' from DER, 545' right of centerline, 639' MSL.

Trees, vehicle on road beginning 282' from DER, 117' right of centerline, up to 666' MSL.

Trees beginning 693' from DER, 160' left of centerline, up to 640' MSL.

Trees beginning 793' from DER, 4' right of centerline, up to 676' MSL.

Tree 1005' from DER, 768' left of centerline, 641' MSL.

Tree 1050' from DER, 114' left of centerline, 652' MSL.

Trees beginning 1126' from DER, 314' left of centerline, up to 679' MSL.

CON'T

**TAKEOFF MINIMUMS, (OBSTACLE) DEPARTURE PROCEDURES, AND
DIVERSE VECTOR AREA (RADAR VECTORS)**

23278

TAKEOFF MINIMUMS, (OBSTACLE) DEPARTURE PROCEDURES, AND DIVERSE VECTOR AREA (RADAR VECTORS)

23278

SAVANNA, IL (CON'T)

TRI-TOWNSHIP (SFY) (CON'T)

- Rwy 31 (CON'T)**, trees beginning 1557' from DER, 223' left of centerline, up to 688' MSL.
Trees beginning 1702' from DER, 38' right of centerline, up to 679' MSL.
Trees beginning 1733' from DER, 28' left of centerline, up to 689' MSL.

SHAWANO, WI

SHAWANO MUNI (EZS)

TAKEOFF MINIMUMS AND (OBSTACLE) DEPARTURE PROCEDURES

AMDT 2A 03APR14 (14093) (FAA)

TAKEOFF MINIMUMS:

- Rwy 12**, 600-3 or std. w/ min. climb of 329' per NM to 1600.
Rwy 17, 300-2 or std. w/ min. climb of 245' per NM to 1200.
Rwy 30, 300-1½ or std. w/ min. climb of 248' per NM to 1100.

TAKEOFF OBSTACLE NOTES:

- Rwy 12**, tower 2.3 NM from DER, 3006' right of centerline, 222' AGL/1240' MSL.
Multiple trees beginning 1700' from DER, 389' left to 2432' right of centerline, up to 100' AGL/1149' MSL.
Rwy 17, multiple trees beginning 1710' from DER, 2951' left to 1292' right of centerline, up to 100' AGL/1059' MSL.
Elevator 5839' from DER, 738' right of centerline, 149' AGL/979' MSL.
Rwy 30, multiple trees beginning 649' from DER, 1052' left to 1117' right of centerline, up to 100' AGL/929' MSL.
Vehicle on road 538' from DER, crossing left to right 17' AGL/826' MSL.
Water tank 1.1 NM from DER, 1310' right of centerline, 175' AGL/1019' MSL.
Rwy 35, ships 1007' from DER, left to right of centerline, up to 60' AGL/869' MSL.
Vehicle on road 580' from DER, left to right of centerline, up to 15' AGL/824' MSL.
Multiple trees beginning 2200' from DER, 724' left of centerline, up to 100' AGL/909' MSL.

SHEBOYGAN, WI

SHEBOYGAN COUNTY MEML (SBM)

TAKEOFF MINIMUMS AND (OBSTACLE) DEPARTURE PROCEDURES

AMDT 2 10JAN13 (21224) (FAA)

TAKEOFF OBSTACLE NOTES:

- Rwy 13**, tree 366' from DER, 106' left of centerline, 31' AGL/761' MSL.
Tree 494' from DER, 33' left of centerline, 24' AGL/754' MSL.
Trees beginning 29' from DER, 391' left of centerline, up to 91' AGL/821' MSL.
Vehicle on road 553' from DER, west to east, 15' AGL/764' MSL.
Poles and trees beginning 543' from DER, 493' right of centerline, up to 62' AGL/805' MSL.
Rwy 22, obstruction light on localizer 157' from DER, 4' left of centerline, 11' AGL/750' MSL.
Aircraft on ramp, 780' from DER, 645' left of centerline, 15' AGL/764' MSL.
Trees 1709' from DER, 35' left of centerline, 83' AGL/794' MSL.
Vehicle on road, 702' from DER, 589' right of centerline, 15' AGL/764' MSL.
Tree 230' from DER, 377' right of centerline, 27' AGL/767' MSL.
Trees 1475' from DER, 291' right of centerline, 92' AGL/792' MSL.
Transmission line tower 5414' from DER, 1625' right of centerline, 133' AGL/883' MSL.
Rwy 31, pole 405' from DER, 40' right of centerline, 27' AGL/777' MSL.
Trees and fence 70' from DER, 352' right of centerline, up to 56' AGL/806' MSL.
Trees 1345' from DER, 482' right of centerline, 76' AGL/826' MSL.
Trees 2227' from DER, 18' right of centerline, 71' AGL/821' MSL.
Trees 1604' from DER, 32' left of centerline, 95' AGL/845' MSL.
Tower 4606' from DER, 920' left of centerline, 139' AGL/889' MSL.
Transmission line tower 4691' from DER, 1003' left of centerline, 140' AGL/890' MSL.

SHELBYVILLE, IL

SHELBY COUNTY (2H0)

TAKEOFF MINIMUMS AND (OBSTACLE) DEPARTURE PROCEDURES

ORIG 03JUN10 (10154) (FAA)

TAKEOFF MINIMUMS:

- Rwys 4, 22, 14, 32**, NA-Environmental.

TAKEOFF OBSTACLE NOTES:

- Rwy 18**, vehicle on roadway 529' from DER, left and right of centerline, 15' AGL/634' MSL.
Building 716' from DER, 561' left of centerline, 25' AGL/644' MSL.
Trees 1755' from DER, left and right of centerline, up to 100' AGL/709' MSL.
Rwy 36, vehicle on roadway 665' from DER, left and right of centerline, 15' AGL/644' MSL.
Trees beginning 835' from DER, 653' right of centerline, up to 100' AGL/709' MSL.
Trees beginning 1500' from DER, 819' left of centerline, up to 100' AGL/709' MSL.

TAKEOFF MINIMUMS, (OBSTACLE) DEPARTURE PROCEDURES, AND DIVERSE VECTOR AREA (RADAR VECTORS)

23278

EC-3

TAKEOFF MINIMUMS, (OBSTACLE) DEPARTURE PROCEDURES, AND DIVERSE VECTOR AREA (RADAR VECTORS)

23278

SHELL LAKE, WI

SHELL LAKE MUNI (SSQ)

TAKEOFF MINIMUMS AND (OBSTACLE) DEPARTURE PROCEDURES

ORIG 14FEB08 (08045) (FAA)

TAKEOFF MINIMUMS:

Rwy 14, 200-1¼ or std. w/min climb of 238' per NM to 1500, or alternatively with std. takeoff minimums and a normal 200' per NM climb gradient, takeoff must occur no later than 2000' prior to DER.

Rwy 32, 200-1¼ or std. w/min climb of 235' per NM to 1500, or alternatively with std. takeoff minimums and normal 200' per NM climb gradient, takeoff must occur no later than 2000' prior to DER.

TAKEOFF OBSTACLE NOTES:

Rwy 14, vehicle and road 91' from DER, 167' left of centerline, up to 15' AGL/1244' MSL.

Trees beginning 147' from DER, 89' right of centerline up to 100' AGL/1409' MSL.

Vehicle and road 218' from DER, 144' right of centerline, up to 15' AGL/1244' MSL.

Trees beginning 358' from DER, 306' left of centerline up to 100' AGL/1329' MSL.

Rwy 32, vehicle and road 84' from departure end of runway, 3' left of centerline, up to 15' AGL/1264' MSL.

Railroad 347' from DER, 56' left of centerline, up to 23' AGL/1272' MSL.

Vehicle and road 745' from DER 30' right of centerline, up to 15' AGL/1274' MSL.

Railroad 827' from DER, 686' right of centerline, up to 23' AGL/1272' MSL.

Trees 2467' from DER, 853' right of centerline, up to 100' AGL/1349' MSL.

Trees 2645' from DER, 100' left of centerline, up to 100' AGL/1419' MSL.

SIREN, WI

BURNETT COUNTY (RZN)

TAKEOFF MINIMUMS AND (OBSTACLE) DEPARTURE PROCEDURES

ORIG 02MAY13 (13122) (FAA)

TAKEOFF OBSTACLE NOTES:

Rwy 5, trees beginning 89' from DER, 18' left of centerline, up to 46' AGL/1035' MSL.

Trees beginning 546' from DER 144' right of centerline, up to 55' AGL/1044' MSL.

Trees beginning 1020' from DER, 33' left of centerline, up to 74' AGL/1063' MSL.

Trees beginning 1026' from DER 28' right of centerline, up to 81' AGL/1070' MSL.

Poles beginning 221' from DER, 227' right of centerline, up to 30' AGL/1014' MSL.

Vehicles on road, beginning 147' from DER, 181' right of centerline, up to 15' AGL/1002' MSL.

Building 450' from DER, 471' right of centerline, 18' AGL/1007' MSL.

Equipment 96' from DER, 474' right of centerline, 3' AGL/987' MSL.

Rwy 14, trees beginning 271' from DER, 351' left of centerline, up to 37' AGL/1026' MSL.

Trees beginning 493' from DER, 439' right of centerline, up to 64' AGL/1053' MSL.

Trees beginning 1277' from DER, 13' left of centerline, up to 98' AGL/1087' MSL.

Trees beginning 1198' from DER, 7' right of centerline, up to 107' AGL/1096' MSL.

Vehicles on road, beginning 306' from DER, 56' right and left of centerline, up to 15' AGL/ MSL.

Poles beginning 667' from DER, 207' right of centerline, up to 45' AGL/1007' MSL.

Poles beginning 679' from DER, 41' left of centerline, up to 38' AGL/1027' MSL.

Building 1168' from DER, 90' right of centerline, 35' AGL/1019' MSL.

Rwy 23, trees beginning 56' from DER, 267' left of centerline, up to 62' AGL/1051' MSL.

Trees beginning 35' from DER, 49' right of centerline, up to 19' AGL/1008' MSL.

Trees beginning 1086' from DER, 10' left of centerline, up to 79' AGL/1068' MSL.

Trees beginning 1091' from DER, 8' right of centerline, up to 75' AGL/1069' MSL.

REIL 10' from DER, 76' left of centerline, 7' AGL/991' MSL.

REIL 10' from DER, 77' right of centerline, 6' AGL/990' MSL.

Pole 1655' from DER, 10' left of centerline, 50' AGL/1034' MSL.

Rwy 32, trees beginning 1174' from DER, 449' left of centerline, up to 45' AGL/1029' MSL.

Trees beginning 297' from DER, 522' right of centerline, up to 50' AGL/1039' MSL.

Trees beginning 1400' from DER, 23' left of centerline, up to 78' AGL/1062' MSL.

Trees beginning 1057' from DER, 23' right of centerline, up to 72' AGL/1056' MSL.

Poles beginning 942' from DER, 83' left of centerline, up to 49' AGL/1033' MSL.

Poles beginning 871' from DER, 393' right of centerline, up to 29' AGL/1018' MSL.

Vehicles on road, beginning 118' from DER, 521' left of centerline, up to 15' AGL/998' MSL.

22 FEB 2024 to 21 MAR 2024

22 FEB 2024 to 21 MAR 2024

TAKEOFF MINIMUMS, (OBSTACLE) DEPARTURE PROCEDURES, AND DIVERSE VECTOR AREA (RADAR VECTORS)

23278

TAKEOFF MINIMUMS, (OBSTACLE) DEPARTURE PROCEDURES, AND DIVERSE VECTOR AREA (RADAR VECTORS)

23278

SOLON SPRINGS, WI

SOLON SPRINGS MUNI (OLG)

TAKEOFF MINIMUMS AND (OBSTACLE) DEPARTURE PROCEDURES

ORIG 20OCT11 (11293) (FAA)

TAKEOFF OBSTACLE NOTES:

- Rwy 1**, building 37' from DER, 509' right of centerline, 19' AGL/1119' MSL.
- Trees beginning 55' from DER, 329' left of centerline, up to 49' AGL/1149' MSL.
- Vehicles on roadway left and right of centerline beginning 77' from DER, up to 15' AGL/1114' MSL.
- Poles beginning 785' from DER, 526' right of centerline, up to 43' AGL/1143' MSL.
- Trees beginning 1140' from DER, 277' right of centerline, up to 48' AGL/1148' MSL.
- Trees left and right of centerline beginning 1474' from DER, up to 61' AGL/1161' MSL.
- Rwy 19**, structure 12' from DER, 20' left of centerline, 3' AGL/1104' MSL.
- Vehicles on roadway beginning 20' from DER, 248' right of centerline, up to 15' AGL/1116' MSL.
- Terrain 40' from DER, 109' right of centerline, 1104' MSL.
- Trees beginning 45' from DER, 307' right of centerline, up to 40' AGL/1141' MSL.
- Trees beginning 74' from DER, 319' left of centerline, up to 75' AGL/1176' MSL.
- Trees left and right of centerline beginning 1027' from DER, up to 54' AGL/1155' MSL.
- Transmission line beginning 2455' from DER, 740' right of centerline, up to 123' AGL/1224' MSL.
- Trees beginning 2539' from DER, 631' left of centerline, up to 85' AGL/1186' MSL.

SPARTA, IL

SPARTA COMMUNITY-HUNTER FLD (SAR)

TAKEOFF MINIMUMS AND (OBSTACLE) DEPARTURE PROCEDURES

AMDT 1 07FEB13 (21112) (FAA)

TAKEOFF MINIMUMS:

- Rwys 9, 27**, NA - Environmental.
- Rwy 18**, 300-1¼ or std. w/ min. climb of 316' per NM to 1000 MSL.

TAKEOFF OBSTACLE NOTES:

- Rwy 18**, tower 1.4 NM from DER, 771' right of centerline, 260' AGL/780' MSL.
- Multiple light poles beginning 41' from DER, 495' right of centerline, up to 33' AGL/572' MSL.
- Antenna 1838' from DER, 615' right of centerline, 51' AGL/590' MSL.
- Multiple buildings beginning at 388' from DER, 378' right of centerline, up to 38' AGL/569' MSL.
- Trees beginning 119' from DER, 65' left of centerline, up to 100' AGL/580' MSL.
- Trees beginning 9' from DER, 8' right of centerline, up to 100' AGL/630' MSL.
- Water tower 5238' from DER, 666' right of centerline, 140' AGL/669' MSL.
- Sign 12' from DER, 152' right of centerline, 5' AGL/526' MSL.
- Vehicles on road beginning 500' from DER, 144' right of centerline, 15' AGL/536' MSL.
- Rwy 36**, trees beginning 165' from DER, 166' left of centerline, up to 100' AGL/610' MSL.
- Trees beginning 612' from DER, 413' right of centerline, up to 100' AGL/619' MSL.

SPARTA, WI

SPARTA/FORT MC COY (CMY)

TAKEOFF MINIMUMS AND (OBSTACLE) DEPARTURE PROCEDURES

AMDT 2 30JUN11 (11181) (FAA)

TAKEOFF MINIMUMS:

- Rwy 1**, 400-1½.
- Rwy 19**, 500-2½ w/ min. climb of 217' per NM to 1800 or std. w/min. climb of 425' per NM to 1500, or 1100-2½, for climb in visual conditions.

DEPARTURE PROCEDURE:

- Rwy 1**, climb heading 030° to 1600 before turning on course.
- Rwy 11**, climb heading 112° to 1800 before turning on course.
- Rwy 19**, climb heading 195° to 1500 before turning on course.
- Rwy 29**, climb heading 287° to 1500 before turning on course. For climb in visual conditions. Cross Sparta/Fort Mc Coy airport at or above 1800' MSL before proceeding on course.

TAKEOFF OBSTACLE NOTES:

- Rwy 1**, rising terrain beginning 14' from DER, left and right of centerline, up to 1019' MSL.
- Trees beginning 73' from DER, left and right of centerline, up to 100' AGL/1119' MSL.
- Vehicles on road beginning 1437' from DER, left and right of centerline, up to 15' AGL/874' MSL.
- Rwy 11**, Obstruction light on pole 759' from DER, 232' left of centerline, 26' AGL/854' MSL.
- Trees beginning 989' from DER, left and right of centerline, up to 100' AGL/949' MSL.
- Rwy 19**, trees beginning 99' from DER, left and right of centerline, up to 100' AGL/1239' MSL.
- Ridge 8695' from DER, 2008' left of centerline, 0' AGL/1122' MSL.
- Rwy 29**, trees beginning 802' from DER, 31' left of centerline, up to 61' AGL/879' MSL.
- Pole 1447' from DER, 432' right of centerline, 50' AGL/866' MSL.

22 FEB 2024 to 21 MAR 2024

22 FEB 2024 to 21 MAR 2024

TAKEOFF MINIMUMS, (OBSTACLE) DEPARTURE PROCEDURES, AND DIVERSE VECTOR AREA (RADAR VECTORS)

23278

EC-3

TAKEOFF MINIMUMS, (OBSTACLE) DEPARTURE PROCEDURES, AND DIVERSE VECTOR AREA (RADAR VECTORS)

23278

SPRINGFIELD, IL

ABRAHAM LINCOLN CAPITAL (SPI)

TAKEOFF MINIMUMS AND (OBSTACLE) DEPARTURE PROCEDURES

ORIG-A 15JUN23 (23166) (FAA)

TAKEOFF OBSTACLE NOTES:

Rwy 4, multiple trees beginning 1456' from DER, 734' left of centerline, up to 59' AGL/650' MSL.

Rwy 13, bush 342' from DER, 299' right of centerline, 43' AGL/592' MSL.

Rwy 31, multiple trees beginning 1641' from DER, 619' left of centerline, up to 81' AGL/665' MSL.

STERLING-ROCKFALLS, IL

WHITESIDE COUNTY/JOS H BITTORF FLD (SQI)

TAKEOFF MINIMUMS AND (OBSTACLE) DEPARTURE PROCEDURES

ORIG 20NOV08 (21224) (FAA)

TAKEOFF OBSTACLE NOTES:

Rwy 7, elevator 3095' from DER, 1099' right of centerline, 91' AGL/741' MSL.

Rwy 18, vehicle on roadway 736' from DER, on centerline, 15' AGL/664' MSL.

Tree 1012' from DER, 288' left of centerline, 35' AGL/680' MSL.

Tree 787' from DER, 120' right of centerline, 29' AGL/669' MSL.

Multiple trees beginning 3619' from DER, 944' left of centerline, up to 100' AGL/769' MSL.

Rwy 25, multiple trees beginning 1308' from DER, 22' left of centerline, up to 82' AGL/732' MSL.

Multiple trees beginning 666' from DER, 42' right of centerline, up to 80' AGL/720' MSL.

Rwy 36, vehicle on roadway, 575' from DER, on centerline, 17' AGL/668' MSL.

Tree 564' from DER, 103' right of centerline, 11' AGL/662' MSL.

STEVENS POINT, WI

STEVENS POINT MUNI (STE)

TAKEOFF MINIMUMS AND (OBSTACLE) DEPARTURE PROCEDURES

ORIG 15JAN09 (09015) (FAA)

TAKEOFF OBSTACLE NOTES:

Rwy 3, trees beginning 1175' from DER, 649' left of centerline, 54' AGL/1173' MSL.

Tree 2693' from DER, 556' right of centerline, 62' AGL/1181' MSL.

Rwy 21, trees beginning 1127' from DER, 119' right of centerline, up to 100' AGL/1209' MSL.

Trees beginning 1247' from DER, 151' left of centerline, up to 45' AGL/1153' MSL.

Rwy 12, poles beginning 177' from DER, 197' right of centerline, up to 37' AGL/1126' MSL.

Trees beginning 757' from DER, 27' right of centerline, up to 95' AGL/1204' MSL.

Trees beginning 958' from DER, 112' left of centerline, up to 87' AGL/1196' MSL.

Rwy 30, building 217' from DER, 535' left of centerline, 30' AGL/1139' MSL.

Vehicle and road 499' from DER, on centerline, 15' AGL/1124' MSL.

Trees beginning 848' from DER, 66' left of centerline, up to 87' AGL/1206' MSL.

Trees beginning 869' from DER, 139' right of centerline, up to 81' AGL/1210' MSL.

STURGEON BAY, WI

DOOR COUNTY CHERRYLAND (SUE)

TAKEOFF MINIMUMS AND (OBSTACLE) DEPARTURE PROCEDURES

AMDT 1 03DEC20 (20338) (FAA)

TAKEOFF MINIMUMS:

Rwy 10, 300-1% or std. w/min. climb of 305' per NM to 1100.

DEPARTURE PROCEDURE:

Rwy 2, climb on heading 016° to 1600 before turning right.

TAKEOFF OBSTACLE NOTES:

Rwy 10, lighting 9' from DER, 77' left of centerline, 717' MSL.

Lighting 10' from DER, 78' right of centerline, 717' MSL.

Traverse way beginning 17' from DER, 347' right of centerline, up to 721' MSL.

Tree 139' from DER, 495' left of centerline, 740' MSL.

Tree 233' from DER, 505' left of centerline, 758' MSL.

Trees beginning 303' from DER, 9' left of centerline, up to 100' AGL/829' MSL.

Trees beginning 438' from DER, 217' right of centerline, up to 767' MSL.

Trees beginning 710' from DER, 347' right of centerline, up to 771' MSL.

Trees beginning 733' from DER, 20' right of centerline, up to 780' MSL.

Crane 1.1 NM from DER, 64' left of centerline, 344' AGL/925' MSL.

Crane 1.2 NM from DER, 91' right of centerline, 344' AGL/924' MSL.

Crane 1.3 NM from DER, 249' right of centerline, 344' AGL/924' MSL.

Rwy 20, terrain 122' from DER, 473' right of centerline, 726' MSL.

Pole 203' from DER, 511' right of centerline, 748' MSL.

Pole 321' from DER, 557' left of centerline, 29' AGL/747' MSL.

Pole, traverse way, tree, building beginning 556' from DER, 404' right of centerline, up to 33' AGL/754' MSL.

Trees beginning 576' from DER, 396' left of centerline, up to 769' MSL.

Tree 961' from DER, 375' right of centerline, 763' MSL.

Tree 1972' from DER, 517' right of centerline, 779' MSL.

Trees beginning 2098' from DER, 248' left of centerline, up to 787' MSL.

Trees beginning 2600' from DER, 560' right of centerline, up to 802' MSL.

CONT

TAKEOFF MINIMUMS, (OBSTACLE) DEPARTURE PROCEDURES, AND DIVERSE VECTOR AREA (RADAR VECTORS)

23278

TAKEOFF MINIMUMS, (OBSTACLE) DEPARTURE PROCEDURES, AND DIVERSE VECTOR AREA (RADAR VECTORS)

23278

STURGEON BAY, WI (CON'T)

DOOR COUNTY CHERRYLAND (SUE) (CON'T)

Rwy 28, lighting 11' from DER, 76' right of centerline, 720' MSL.

Lighting 11' from DER, 77' left of centerline, 720' MSL.

Building 66' from DER, 475' left of centerline, 17' AGL/738' MSL.

Building, traverse way, tree beginning 71' from DER, 419' left of centerline, up to 748' MSL.

Tree 613' from DER, 513' right of centerline, 749' MSL.

Tree 2612' from DER, 451' right of centerline, 787' MSL.

SUPERIOR, WI

RICHARD I BONG (SUW)

TAKEOFF MINIMUMS AND (OBSTACLE) DEPARTURE PROCEDURES

AMDT 6 03APR14 (14093) (FAA)

TAKEOFF MINIMUMS:

Rwy 4, 300-1 or std. w/min. climb of 386' per NM to 1000.

DEPARTURE PROCEDURE:

Rwy 4, climb heading 038° to 1900 before turning left.

Rwy 14, climb heading 141° to 1200 before proceeding on course.

Rwy 22, climb heading 218° to 1300 before proceeding on course.

Rwy 32, climb heading 321° to 2200 before turning right.

TAKEOFF OBSTACLE NOTES:

Rwy 4, NAVAID 11' from DER, 78' right of centerline, 3' AGL/661' MSL.

Bush and trees beginning 4' from DER, 150' left of centerline, up to 20' AGL/671' MSL.

Fence and trees beginning 105' from DER, 202' right of centerline, up to 24' AGL/677' MSL.

Train on railroad beginning 459' from DER, 494' right of centerline, up to 23' AGL/684' MSL.

Trees beginning 535' from DER, 375' left of centerline, up to 48' AGL/699' MSL.

Trees beginning 865' from DER, 599' right of centerline, up to 49' AGL/700' MSL.

Trees beginning 965' from DER, crossing centerline, up to 55' AGL/706' MSL.

Poles beginning 1692' from DER, 663' left of centerline, up to 64' AGL/715' MSL.

Chimney 4059' from DER, 1488' left of centerline, 225' AGL/861' MSL.

Rwy 14, NAVAID 49' from DER, 99' left of centerline, 3' AGL/675' MSL.

NAVAID 50' from DER, 102' right of centerline, 3' AGL/675' MSL.

Tree 424' from DER, 568' right of centerline, 16' AGL/687' MSL.

Vehicle on road beginning 506' from DER, crossing centerline, up to 15' AGL/689' MSL.

Trees beginning 573' from DER, 29' right of centerline, up to 35' AGL/706' MSL.

Trees beginning 579' from DER, 216' left of centerline, up to 21' AGL/692' MSL.

Train on railroad beginning 805' from DER, crossing centerline, up to 23' AGL/698' MSL.

Trees beginning 1083' from DER, 119' right of centerline, up to 45' AGL/711' MSL.

Pole 1794' from DER, 956' left of centerline, 77' AGL/738' MSL.

Pole 2166' from DER, 643' left of centerline, 72' AGL/733' MSL.

Rwy 22, terrain 5' from DER, 380' left of centerline, 673' MSL.

NAVAID 11' from DER, 78' right of centerline, 3' AGL/671' MSL.

NAVAID 12' from DER, 77' left of centerline, 3' AGL/673' MSL.

Trees beginning 84' from DER, 329' right of centerline, up to 14' AGL/675' MSL.

Poles beginning 689' from DER, 424' right of centerline, up to 25' AGL/696' MSL.

Pole 1312' from DER, 793' left of centerline, 47' AGL/708' MSL.

Building 1578' from DER, 831' right of centerline, 49' AGL/720' MSL.

Rwy 32, NAVAID 49' from DER, 102' right of centerline, 3' AGL/674' MSL.

NAVAID 50' from DER, 101' left of centerline, 3' AGL/674' MSL.

Poles beginning 667' from DER, 413' left of centerline, up to 25' AGL/696' MSL.

Sign and trees beginning 1023' from DER, 117' left of centerline, up to 43' AGL/714' MSL.

Trees beginning 1380' from DER, 23' right of centerline, up to 59' AGL/720' MSL.

Tree 1481' from DER, 825' right of centerline, 51' AGL/712' MSL.

Communication towers beginning 3136' from DER, 1112' left of centerline, up to 118' AGL/779' MSL.

TAYLORVILLE, IL

TAYLORVILLE MUNI (TAZ)

TAKEOFF MINIMUMS AND (OBSTACLE) DEPARTURE PROCEDURES

ORIG-A 11AUG22 (22223) (FAA)

TAKEOFF MINIMUMS:

Rwys 9L, 27R, NA-Turf runway.

Rwys 9R, 27L, NA-Obstacles.

TAKEOFF OBSTACLE NOTES:

Rwy 18, numerous trees 1000' from DER, from 335' left of centerline to 1150' right of centerline, up to 100' AGL/719' MSL.

Rwy 36, numerous trees 1580' from DER, from 20' left of centerline to 570' right of centerline, up to 100' AGL/724' MSL.

22 FEB 2024 to 21 MAR 2024

22 FEB 2024 to 21 MAR 2024

TAKEOFF MINIMUMS, (OBSTACLE) DEPARTURE PROCEDURES, AND DIVERSE VECTOR AREA (RADAR VECTORS)

23278

EC-3

TAKEOFF MINIMUMS, (OBSTACLE) DEPARTURE PROCEDURES, AND DIVERSE VECTOR AREA (RADAR VECTORS)

23278

TOMAH, WI

BLOYER FLD (Y72)

TAKEOFF MINIMUMS AND (OBSTACLE) DEPARTURE PROCEDURES

ORIG 10DEC15 (21224) (FAA)

TAKEOFF MINIMUMS:

Rwy 25, 300-1½ or std. w/min. climb of 295' per NM to 1400.

DEPARTURE PROCEDURE:

Rwy 25, climb heading 248° to 1500 before proceeding on course.

TAKEOFF OBSTACLE NOTES:

Rwy 7, trees beginning 6' from DER, 442' left of centerline, up to 70' AGL/1028' MSL.

Trees beginning 58' from DER, 373' right of center, up to 59' AGL/1019' MSL.

Trees beginning 224' from DER, 192' right of centerline, up to 68' AGL/1028' MSL.

Rr 615' from DER, 566 left of centerline, 23' AGL/983' MSL.

Trees beginning 1091' from DER, 500' left of centerline, up to 82' AGL/1042' MSL.

Trees beginning 1180 from DER, crossing centerline, up to 99' AGL/1049' MSL.

Rwy 25, building 3' from DER, 430' left of centerline, 26' AGL/976' MSL.

Buildings beginning 122' from DER, 388' left of centerline, up to 16' AGL/980' MSL.

Tree tops, poles and cranes (mobile) beginning 288' from DER, right to left of centerline, up to 40' AGL/1010' MSL.

Vehicle on road (n) beginning 512' from DER, crossing centerline, 15' AGL/987' MSL.

Trees, utility pole tops, poles, treetops and transmission towers beginning 596' from DER, left to right of centerline, up to 59' AGL/1029' MSL.

Poles, ant, utility pole tops, sign, and trees beginning 605' from DER, left to right of centerline, up to 30' AGL/999' MSL.

Treetops, cranes (mobile), trees, utility pole tops, and transmission towers beginning 735' from DER, right to left of centerline, up to 50' AGL/1020' MSL.

Transmission towers and trees beginning 843' from DER, right to left of centerline, up to 74' AGL/1044' MSL.

Trees, TL tower, and pole beginning 2361' from DER, left to right of centerline, up to 85' AGL/1055' MSL.

Tower and OL communication beginning 1.21 NM from DER, 713' right of centerline, up to 207' AGL/1177' MSL.

TOMAHAWK, WI

TOMAHAWK RGNL (TKV)

TAKEOFF MINIMUMS AND (OBSTACLE) DEPARTURE PROCEDURES

AMDT 1 31MAY12 (12152) (FAA)

TAKEOFF OBSTACLE NOTES:

Rwy 9, vehicles on road 160' from DER, right and left of runway, up to 15' AGL/1494' MSL.

Trees beginning 2' from DER, right and left of runway, up to 100' AGL/1599' MSL.

Rwy 27, obstruction light on windsock 10' from DER, 400' left of centerline, 25' AGL/1496' MSL.

Vehicle on road 11' from DER, right and left of runway, 15' AGL/1479' MSL.

Trees beginning 40' from DER, right and left of centerline, up to 100' AGL/1599' MSL.

VANDALIA, IL

VANDALIA MUNI (VLA)

TAKEOFF MINIMUMS AND (OBSTACLE) DEPARTURE PROCEDURES

ORIG 31MAY12 (12152) (FAA)

TAKEOFF OBSTACLE NOTES:

Rwy 9, trees 2563' from DER, 140' right of centerline, 100' AGL/649' MSL.

Trees 3364' from DER, 740' left of centerline, 100' AGL/644' MSL.

Rwy 18, trees 764' from DER, 519' right of centerline, 100' AGL/629' MSL.

Trees beginning 3115' from DER, 293' left of centerline, 100' AGL/659' MSL.

Rwy 27, trees beginning 1581' from DER, 885' right of centerline, 100' AGL/659' MSL.

Trees beginning 2548' from DER, 4' to 1230' left of centerline, 100' AGL/649' MSL.

Rwy 36, trees beginning 256' from DER, 327' to 882' right of centerline, 100' AGL/659' MSL.

Trees beginning 1834' from DER, 288' to 1548' left of centerline, 100' AGL/649' MSL.

VIROQUA, WI

VIROQUA MUNI (Y51)

TAKEOFF MINIMUMS AND (OBSTACLE) DEPARTURE PROCEDURES

AMDT 2 23APR20 (20114) (FAA)

TAKEOFF MINIMUMS:

Rwys 2, 20, NA - Environmental.

Rwy 11, 300-1 or std. w/min. climb of 460' per NM to 1500.

TAKEOFF OBSTACLE NOTES:

Rwy 11, tree 1' from DER, 448' left of centerline, 1302' MSL.

Poles and signs beginning 24' from DER, 148' right of centerline, up to 34' AGL/1319' MSL.

Poles and buildings beginning 153' from DER, 424' right of centerline, up to 33' AGL/1325' MSL.

Building 537' from DER, 430' right of centerline, 42' AGL/1328' MSL.

Water tower, tank, elevator and rig beginning 2689' from DER, 439' right of centerline, up to 149' AGL/1445' MSL.

Elevator and rig beginning 4215' from DER, 51' left of centerline, up to 139' AGL/1423' MSL.

Rwy 29, lighting 10' from DER, 10' right of centerline, 3' AGL/1265' MSL.

Tree 53' from DER, 339' left of centerline, 1286' MSL.

Trees beginning 181' from DER, 387' left of centerline, up to 1306' MSL.

TAKEOFF MINIMUMS, (OBSTACLE) DEPARTURE PROCEDURES, AND DIVERSE VECTOR AREA (RADAR VECTORS)

23278

EC-3

TAKEOFF MINIMUMS, (OBSTACLE) DEPARTURE PROCEDURES, AND DIVERSE VECTOR AREA (RADAR VECTORS)

23278

VOLK FLD (KVOK)

CAMP DOUGLAS, WI

TAKEOFF MINIMUMS AND (OBSTACLE) DEPARTURE PROCEDURES

24MAR22 (22083) (USAF)

TAKEOFF OBSTACLE NOTES:

Rwy 27, trees 2537' from DER, 983' right of centerline, 80' AGL/1019' MSL.

Trees 3742' from DER, 835' left of centerline, 80' AGL/1039' MSL.

Rwy 9, antenna 4966' from DER, 625' left of centerline, 50' AGL/1040' MSL.

WASHINGTON ISLAND, WI

WASHINGTON ISLAND (2P2)

TAKEOFF MINIMUMS AND (OBSTACLE) DEPARTURE PROCEDURES

ORIG 08NOV18 (18312) (FAA)

DEPARTURE PROCEDURE:

Use WINEP DEPARTURE.

WATERTOWN, WI

WATERTOWN MUNI (RYV)

TAKEOFF MINIMUMS AND (OBSTACLE) DEPARTURE PROCEDURES

AMDT 1 20JUN19 (19171) (FAA)

TAKEOFF MINIMUMS:

Rwy 5, 300-1% or std. w/min. climb of 295' per NM to 1100.

DEPARTURE PROCEDURE:

Rwy 29, climb heading 293° to 1500 before turning north.

TAKEOFF OBSTACLE NOTES:

Rwy 5, vegetation 12' from DER, 400' right of centerline, 838' MSL.

Tree, building beginning 209' from DER, 477' left of centerline, up to 851' MSL.

Building, tree beginning 512' from DER, 310' right of centerline, up to 35' AGL/873' MSL.

Tree 609' from DER, 426' left of centerline, 854' MSL.

Trees, poles, buildings beginning 751' from DER, 51' right of centerline, up to 908' MSL.

Trees beginning 874' from DER, 566' left of centerline, up to 892' MSL.

Tree 1064' from DER, 652' left of centerline, 904' MSL.

Trees beginning 1245' from DER, 407' left of centerline, up to 909' MSL.

Tree 1953' from DER, 227' right of centerline, 914' MSL.

Tree 1968' from DER, 775' right of centerline, 919' MSL.

Tree 2102' from DER, 585' right of centerline, 921' MSL.

Trees, pole beginning 2121' from DER, 15' left of centerline, up to 919' MSL.

Trees, building beginning 2173' from DER, 15' right of centerline, up to 922' MSL.

Trees, transmission line beginning 2492' from DER, 213' right of centerline, up to 934' MSL.

Tree 4164' from DER, 578' left of centerline, 930' MSL.

Rwy 11, vegetation beginning 38' from DER, 329' left of centerline, up to 10' AGL/849' MSL.

Building 230' from DER, 415' left of centerline, 30' AGL/869' MSL.

Building 736' from DER, 530' left of centerline, 35' AGL/890' MSL.

Structure 892' from DER, 582' right of centerline, 30' AGL/889' MSL.

Trees, power pole beginning 947' from DER, 438' right of centerline, up to 100' AGL/949' MSL.

Rwy 23, vehicles on road 248' from DER, 415' left of centerline, 826' MSL.

Pole 742' from DER, 551' left of centerline, 45' AGL/855' MSL.

Pole 1050' from DER, 125' right of centerline, 37' AGL/853' MSL.

Tree, pole beginning 1071' from DER, 10' right of centerline, up to 882' MSL.

Tree, fence beginning 1089' from DER, 105' left of centerline, up to 860' MSL.

Tree 1158' from DER, 687' right of centerline, 889' MSL.

Poles beginning 1238' from DER, 730' right of centerline, up to 45' AGL/897' MSL.

Trees, buildings beginning 1369' from DER, 249' right of centerline, up to 902' MSL.

Trees, tower, building beginning 1599' from DER, 102' left of centerline, up to 893' MSL.

Grain elevator 2329' from DER, 671' left of centerline, 902' MSL.

Rwy 29, buildings beginning 192' from DER, 397' left of centerline, up to 20' AGL/839' MSL.

Tower, vehicles on road, power poles, light poles beginning 360' from DER, 156' left of centerline, up to 75' AGL/894' MSL.

Tree, building beginning 667' from DER, 261' right of centerline, up to 30' AGL/849' MSL.

Tree, pole beginning 875' from DER, 50' right of centerline, up to 100' AGL/919' MSL.

22 FEB 2024 to 21 MAR 2024

22 FEB 2024 to 21 MAR 2024

TAKEOFF MINIMUMS, (OBSTACLE) DEPARTURE PROCEDURES, AND DIVERSE VECTOR AREA (RADAR VECTORS)

23278

TAKEOFF MINIMUMS, (OBSTACLE) DEPARTURE PROCEDURES, AND DIVERSE VECTOR AREA (RADAR VECTORS)

23278

WAUKESHA, WI

WAUKESHA COUNTY (UES)

TAKEOFF MINIMUMS AND (OBSTACLE) DEPARTURE PROCEDURES AMDT 6 07MAY09 (09127) (FAA)

TAKEOFF MINIMUMS:

Rwy 10, 400-2½ or std. with a min. climb of 316' per NM to 1400.

TAKEOFF OBSTACLE NOTES:

Rwy 10, light pole 146' from DER, 326' left of centerline, 9' AGL/918' MSL.

Light pole 560' from DER, 597' left of centerline, 17' AGL/936' MSL.

Pipe on building 229' from DER, 275' left of centerline, 16' AGL/925' MSL.

Trees beginning 1652' from DER, 171' right of centerline, up to 70' AGL/1029' MSL.

Trees beginning 1868' from DER, 16' left of centerline, up to 54' AGL/983' MSL.

Tower 1.0 NM from DER, 1571' right of centerline, 219' AGL/1148' MSL.

Tower 1.1 NM from DER, 1140' right of centerline, 177' AGL/1126' MSL.

Tower 1.8 NM from DER, 3455' right of centerline, 272' AGL/1238' MSL.

Rwy 18, vehicle on road 618' from DER, 162' left of centerline, 15' AGL/946' MSL.

Bush 746' from DER, 107' right of centerline, 9' AGL/938' MSL.

Trees beginning 753' from DER, 187' right of centerline, up to 18' AGL/957' MSL.

Tree 757' from DER, 182' left of centerline, 17' AGL/946' MSL.

Tree 1188' from DER, 27' left of centerline, 27' AGL/956' MSL.

Pole 1976' from DER, 304' left of centerline, 48' AGL/967' MSL.

Pole 2026' from DER, 196' right of centerline, 62' AGL/981' MSL.

Tower 2010' from DER, 932' left of centerline, 66' AGL/984' MSL.

Rod on stack 4489' from DER, 657' left of centerline, 118' AGL/1037' MSL.

Rwy 28, vehicle on road 877' from DER, 541' left of centerline, 15' AGL/924' MSL.

Pole 1078' from DER, 739' left of centerline, 47' AGL/936' MSL.

Rwy 36, rod on pole 401' from DER, 555' left of centerline, 46' AGL/945' MSL.

Vehicle on road 300' from DER, 349' right of centerline, 15' AGL/914' MSL.

Trees beginning 486' from DER, 175' right of centerline, up to 81' AGL/970' MSL.

Trees beginning 999' from DER, 124' left of centerline, up to 72' AGL/962' MSL.

WAUPACA, WI

WAUPACA MUNI (PCZ)

TAKEOFF MINIMUMS AND (OBSTACLE) DEPARTURE PROCEDURES AMDT 2 20JAN05 (05020) (FAA)

TAKEOFF MINIMUMS:

Rwy 28, 300-2 or std. w/min. climb of 317' per NM to 1300.

TAKEOFF OBSTACLE NOTES:

Rwy 10, trees 1400' from DER, 300' left of centerline, 41' AGL/850' MSL.

Rwy 13, road and vehicle 240' from DER, 275' right of centerline, 29' AGL/832' MSL.

Rwy 28, trees 1.1 NM from DER, 1848' left of centerline, 100' AGL, 1119' MSL.

Rwy 31, trees 800' from DER, 150' left of centerline, 19' AGL/846' MSL.

Trees 1965' from DER, 585' left of centerline, 100' AGL/979' MSL.

WAUSAU, WI

WAUSAU DOWNTOWN (AUW)

TAKEOFF MINIMUMS AND (OBSTACLE) DEPARTURE PROCEDURES AMDT 6A 28FEB19 (19059) (FAA)

TAKEOFF MINIMUMS:

Rwys 12W, 30W, NA- Environmental.

Rwy 5, 400-2½ or std. w/min. climb of 378' per NM to 1700.

Rwy 23, 700-3 or std. w/min. climb of 362' per NM to 2100.

DEPARTURE PROCEDURE:

Rwy 5, climb heading 047° to 2100 before proceeding on course.

Rwy 13, climb heading 127° to 2200 before proceeding on course.

Rwy 23, climb heading 227° to 2800 before proceeding on course.

Rwy 31, climb heading 307° to 2800 before proceeding on course.

TAKEOFF OBSTACLE NOTES:

Rwy 5, trees beginning 885' from DER, 53' right of centerline, up to 100' AGL/1409' MSL.

Rising terrain and trees beginning 4552' from DER, right to left of centerline, up to 100' AGL/1529' MSL.

Rwy 13, boat with mast beginning 215' from DER, 498' right of centerline, up to 100' AGL/1222' MSL.

Rwy 23, trees and boats with masts beginning 299' from DER, 8' right of centerline, up to 100' AGL/1269' MSL.

Trees and boats with masts beginning 332' from DER, 190' left of centerline, up to 100' AGL/1609' MSL.

Tower 2.3 NM from DER, 3952' left of centerline, 248' AGL/1840' MSL.

Rwy 31, boat with masts beginning 236' from DER, 511' right of centerline, up to 100' AGL/1222' MSL.

Trees and boats with masts beginning 169' from DER, 27' left of centerline, up to 100' AGL/1222' MSL.

TAKEOFF MINIMUMS, (OBSTACLE) DEPARTURE PROCEDURES, AND DIVERSE VECTOR AREA (RADAR VECTORS)

23278

TAKEOFF MINIMUMS, (OBSTACLE) DEPARTURE PROCEDURES, AND

DIVERSE VECTOR AREA (RADAR VECTORS)

23278

WAUTOMA, WI**WAUTOMA MUNI (Y50)**

TAKEOFF MINIMUMS AND (OBSTACLE) DEPARTURE PROCEDURES

ORIG-A 16JUN22 (22167) (FAA)

TAKEOFF MINIMUMS:

Rwys 8, 26, NA-Turf runway.

DEPARTURE PROCEDURE:

Rwy 31, climb runway heading to 1800 before turning north.**WEST BEND, WI****WEST BEND MUNI (ETB)**

TAKEOFF MINIMUMS AND (OBSTACLE) DEPARTURE PROCEDURES

ORIG 11FEB10 (10042) (FAA)

TAKEOFF MINIMUMS:

Rwy 13, 300-1¼ or std. w/ a min. climb of 260' per NM to 1200.**Rwy 24**, 300-2 or std. w/ a min. climb of 250' per NM to 1400.**Rwy 31**, 300-1¼ or standard w/ a min. climb of 220' per NM to 1100.

TAKEOFF OBSTACLE NOTES:

Rwy 6, vehicle on roads beginning 15' from DER, 251' left of centerline, up to 17' AGL/959' MSL.

Trees beginning 85' from DER, 2' left of centerline, up to 100' AGL/1019' MSL.

Trees beginning 47' from DER, 91' right of centerline, up to 100' AGL/886' MSL.

Rwy 13, trees beginning 452' from DER, 127' left of centerline, up to 100' AGL/1109' MSL.

Trees beginning 214' from DER, 179' right of centerline, up to 100' AGL/1049' MSL.

Rwy 24, trees beginning 114' from DER, 74' left of centerline, up to 100' AGL/1029' MSL.

Trees beginning 89' from DER, 120' right of centerline, up to 100' AGL/969' MSL.

Tower 1.9 NM from DER, 2572' right of centerline, 196' AGL/1156' MSL.

Rwy 31, vehicle on road 99' from DER, 492' left of centerline, 15' AGL/904' MSL.

Trees beginning 550' from DER, 173' left of centerline, up to 100' AGL/1039' MSL.

Vehicle on road 61' from DER, 498' right of centerline, 15' AGL/906' MSL.

Trees beginning 832' from DER, 236' right of centerline, up to 100' AGL/1009' MSL.

WISCONSIN RAPIDS, WI**ALEXANDER FLD SOUTH WOOD COUNTY (ISW)**

TAKEOFF MINIMUMS AND (OBSTACLE) DEPARTURE PROCEDURES

AMD T 2 10JAN13 (22083) (FAA)

TAKEOFF MINIMUMS:

Rwys 18,36, NA-Environmental.

TAKEOFF OBSTACLE NOTES:

Rwy 2, NAVAJD 9' from DER, 125' right of centerline, 7' AGL/1022' MSL.

Tree 109' from DER, 308' left of centerline, 26' AGL/1041' MSL.

Trees beginning 179' from DER, 313' right of centerline, up to 67' AGL/1082' MSL.

Trees beginning 962' from DER, left and right of centerline, up to 91' AGL/1111' MSL.

Rwy 12, pole 1401' from DER, 93' right of centerline, 97' AGL/1097' MSL.

Trees beginning 2326' from DER, 58' left of centerline, up to 99' AGL/1107' MSL.

Rwy 20, trees beginning 125' from DER, 362' right of centerline, up to 101' AGL/1076' MSL.

Trees beginning 88' from DER, 273' left of centerline, up to 85' AGL/1085' MSL.

Trees beginning 2784' from DER, 126' right of centerline, up to 101' AGL/1093' MSL.

22 FEB 2024 to 21 MAR 2024

22 FEB 2024 to 21 MAR 2024

TAKEOFF MINIMUMS, (OBSTACLE) DEPARTURE PROCEDURES, AND

DIVERSE VECTOR AREA (RADAR VECTORS)

23278

EC-3